

Item:
MTFE22-20/30/40W-3CCT
MTFE24-30/40/50W-3CCT

WATTAGE AND CCT SELECTABLE LED TROFFER LIGHT

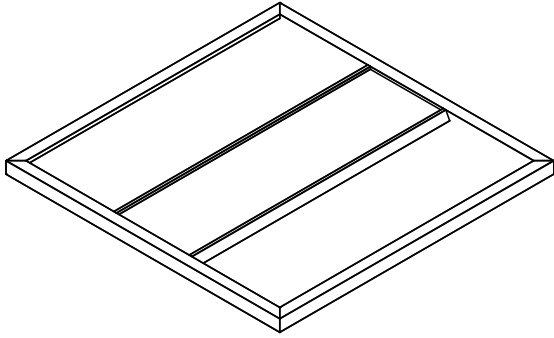

1

PACKAGE CONTENT

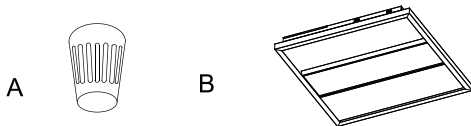

| | PARTS | pcs |
|---|--------------|-----|
| A | Wire Nuts P3 | 5 |
| B | LED fixture | 1 |

WIRING INSTRUCTIONS

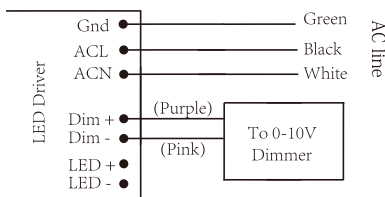

Wiring instructions as shown on the left.
 .Use different socket to wire the AC line and 0-10V dimming controller.
 .Secure the cover back to electrical wiring box after complete the wiring.

3

SAFETY INSTRUCTION

⚠ WARNING

- To reduce the risk of death, personal injury or property damage from fire, electric shock, falling parts, cuts/abrasions, and other hazards read all warnings and instructions included with and on the fixture box and all fixture labels.
- Before installing, servicing, or performing routine maintenance upon this equipment, follow these general precautions.
- Commercial installation, service and maintenance of luminaires should be performed by a qualified licensed electrician.
- For the installation: If you are unsure about the installation or maintenance of the luminaires, consult a qualified licensed electrician and check your local electrical code.
- To prevent wiring damage or abrasion, do not expose wiring to edges of sheet metal or other sharp objects.
- Do not make or alter any open holes in an enclosure of wiring or electrical components during kit installation.

⚠ WARNING

- Turn off electrical power at fuse or circuit breaker box before wiring fixture to the power supply.
- Turn off the power when you perform any maintenance.
- Verify that supply voltage is correct by comparing it with the luminaire label information.
- All wiring connections should be capped with UL approved wire connectors.

⚠ CAUTION

- Avoid direct eye exposure to the light source while it is on.
- Account for small parts and destroy packing material, as these may be hazardous to children.
- Risk of burn. Disconnect power and allow fixture to cool before changing bulb or handing fixture.

NOTICE: Green ground screw provided in proper location. Do not relocate.

NOTICE: Minimum 90° supply conductors.

NOTICE: Specifications and dimensions subject to change without notice.

NOTICE: Suitable for Damp location.

2

INSTALLATION-RECESSED MOUNTING

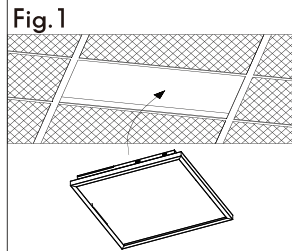

1. Replace existing lighting fixture from ceiling with LED Troffer Light.

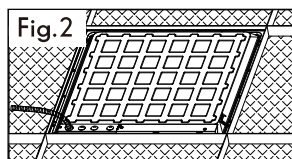

2. Use the protective brackets for the sake of safety. Lift up four protective bracket on the sides of the fixture. Twist the hook 90 degree towards outside as shown on Fig 2.

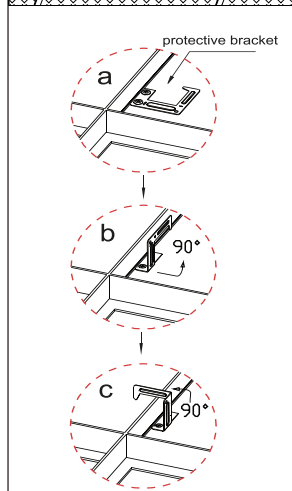

4

INSTALLATION - SURFACE MOUNT

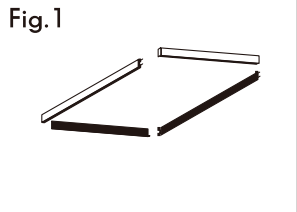

1. Assemble the mounting brackets (sold separately).

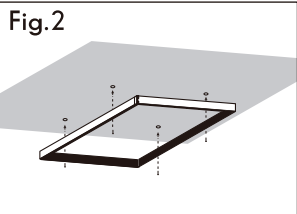

2. Install the brackets (sold separately) to the ceiling with fasteners.

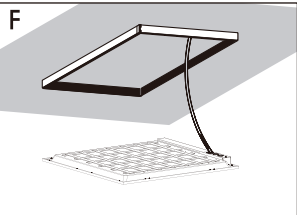

3. Connect the LED Troffer light to the power source.

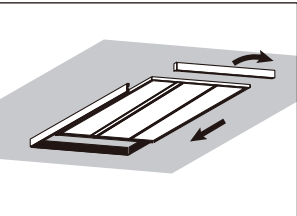

4. Remove one side of the brackets (sold separately) and insert the LED Troffer light to the bracket.

5

INSTALLATION - SURFACE MOUNT

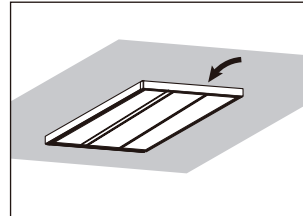

5. Make sure the LED Troffer light fits in the bracket then install the removed bracket back to the fixture to complete the install.

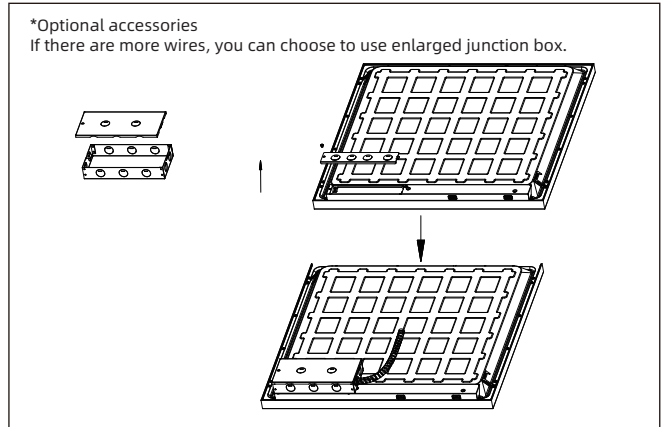

6

FIELD-ADJUSTABLE WATTAGE&CCT

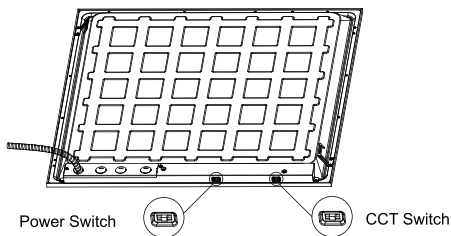

Factory Settings:

| Model | Wattage | CCT |
|-------|---------|-------|
| 2 x 2 | 40W | 5000K |
| 2 x 4 | 50W | 5000K |

The end users may adjust the color temperature (CCT) and lumen output respectively by the two DIP switches integrated into the driver. Each DIP switch is accommodated with 3 options. Corresponding to 3 color temperatures and 3 stages of wattage input, which can perform the desired color temperature and lumen output combination. Select a wattage or color temperature by sliding the switch left or right respectively to desired value.

TROUBLESHOOTING

TROUBLESHOOTING

Fixture does not light

Possible Solution and Corrective Action:

1. Power is off- Check fuse, circuit breaker and switch.
2. Incorrect wire connection- Check wiring.

Circuit breaker trips when turned on

Possible Solution and Corrective Action:

Incorrect wire connection-Check wiring

Flickering when turned on

Possible Solution and Corrective Action:

1. Loose wiring-Check wiring.
2. Faulty switch-Check switch.

WARRANTY

This product is warranted for 5 years from the date of purchase. If this product does not perform to the specifications supplied on this package, send an email for product return and replacement. This replacement is the sole remedy available. Liability for incidental or consequential damage is expressly excluded.

CARE AND MAINTENANCE

Please keep the LED troffer light away from any corrosive substance, and please use dry cloth or alcohol when you clean it.

-Turned off the power before attempt to maintain the luminaire

-Liquid spray should be applied to the cleaning cloth, DO NOT sprayed liquid directly onto the fixture.

7

8