

Item:
LJC-WL-8503-30D-277-S
LJC-WL-8803-30D-277-S

CCT & Wattage Selectable LED Wall Pack Light Fixture

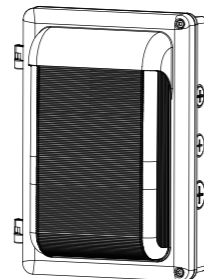

LJC-WL-8503-30D-277-S

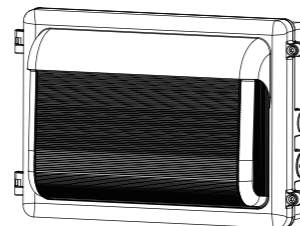

LJC-WL-8803-30D-277-S

Safety Instruction

⚠ WARNING

- To reduce the risk of death, personal injury or property damage from fire, electric shock, falling parts, cuts/abrasions, and other hazards read all warnings and instructions included with and on the fixture box and all fixture labels.
- Before installing, servicing, or performing routine maintenance upon this equipment, follow these general precautions.
- Commercial installation, service and maintenance of luminaires should be performed by a qualified licensed electrician.
- For the installation: If you are unsure about the installation or maintenance of the luminaires, consult a qualified licensed electrician and check your local electrical code.
- To prevent wiring damage or abrasion, do not expose wiring to edges of sheet metal or other sharp objects.
- Do not make or alter any open holes in an enclosure of wiring or electrical components during kit installation.

⚠ WARNING

- Turn off electrical power at fuse or circuit breaker box before wiring fixture to the power supply.
- Turn off the power when you perform any maintenance.
- Verify that supply voltage is correct by comparing it with the luminaire label information.
- All wiring connections should be capped with UL approved wire connectors.

⚠ CAUTION

- Avoid direct eye exposure to the light source while it is on.
 - Account for small parts and destroy packing material, as these may be hazardous to children.
 - Risk of burn. Disconnect power and allow fixture to cool before changing bulb or handling fixture.
- NOTICE: Green ground screw provided in proper location. Do not relocate.
NOTICE: Minimum 90° supply conductors.
NOTICE: Specifications and dimensions subject to change without notice.
NOTICE: Suitable for Wet location.

Tools Required

NOTE: Keep your receipt and these instructions for Proof of Purchase.



Package content

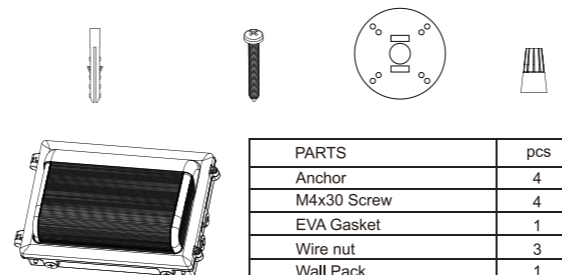

General Wiring Diagram

Electrical Connection Wiring:

1. Connect BLACK/BROWN (line) driver lead to voltage supply Line position (HOT).
 2. Connect driver WHITE/BLUE lead to the NEUTRAL supply position.
 3. Connect the GREEN/YELLOW ground lead to the supply ground lead.
- 0-10v Dimming:
4. Connect PURPLE lead to supply POSITIVE dimming lead.
 5. Connect PINK lead to the supply NEGATIVE dimming lead.
- NOT Using 0-10v Dimming:
6. Ensure PURPLE and PINK 0-10V dimming leads are properly capped.

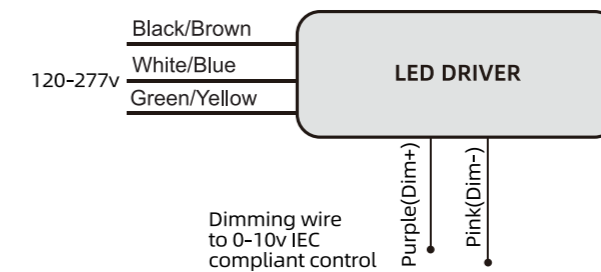

Operating Instructions

Operating temperature: -40°C to 50°C
Input voltage range: 120-277V, 50/60 HZ

Note:

Add a bead of exterior grade silicone sealant around the perimeter of the wall pack on the wall to inhibit any moisture from attachment bolts.

Junction Box Mounting:

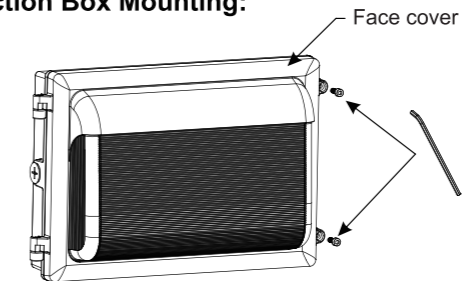

1. Use an Allen wrench to unscrew the 2 screws on the cover.

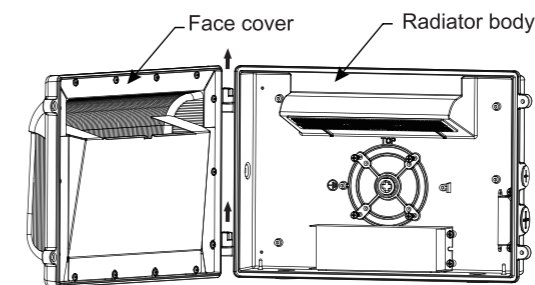

2. Remove the Face cover upwards.

Operating Instructions

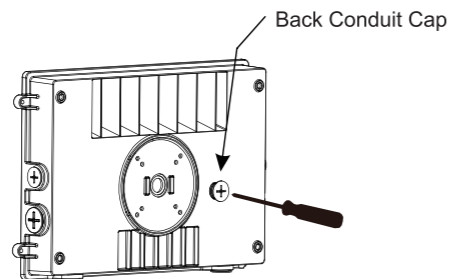

3. Use a screwdriver to unscrew the back conduit cap of the radiator body.

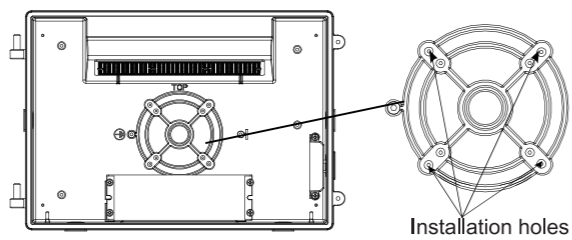

4. Use a hand drill to drill through installation holes.

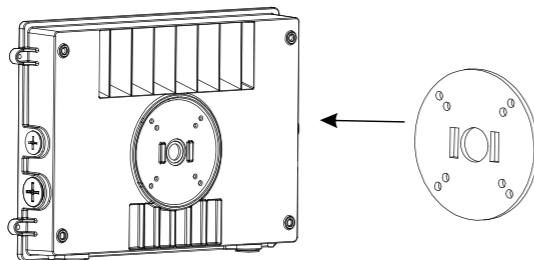

5. Peel off the protective film of the foam gasket (provided) and stick it to the housing back plate.

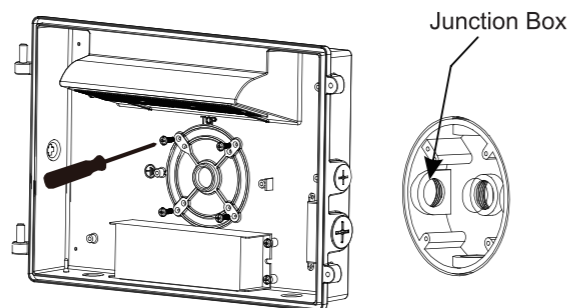

6. Mount housing back plate to surface or junction box (not included) and secure with 4 screws.

Operating Instructions

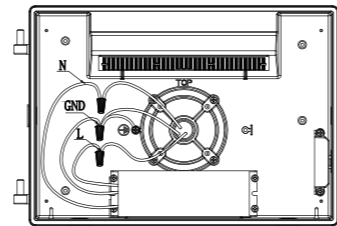

7. Feed supply wires through housing back plate, wire the Housing leads to supply wires using UL listed wire connectors according to NEC and local codes. Push all wires into the housing.

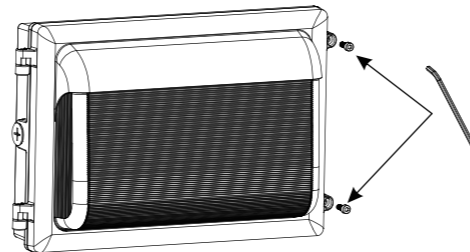

8. Mount return the face cover and secure the 2 screws on the cover.

Hose Installation:

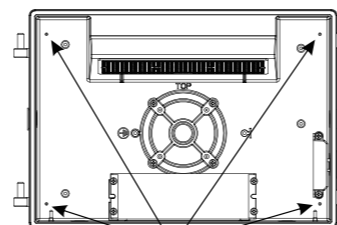

1. Drill four screw holes with a hand drill.

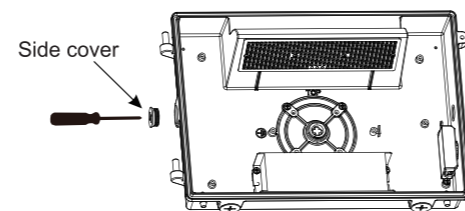

2. Use a screwdriver to unscrew the side cover.

Operating Instructions

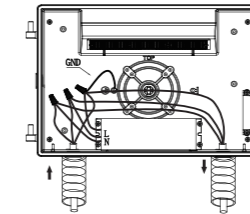

3. Fix the main body of the radiator and connect the cables and power cords from the side accordingly.

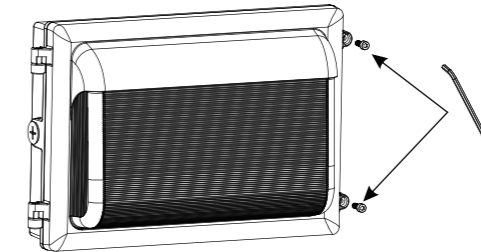

4. Mount return the face cover and secure the 2 screws on the cover.

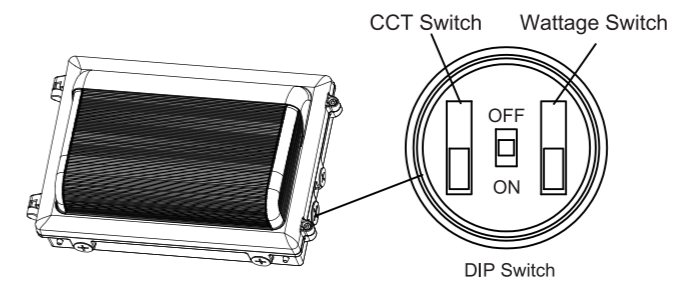

The lamp has 3 selectable CCTs and 3 wattages.

1. Unscrew the DIP Switch by screwdriver.
 2. Toggle the DIP switch to the corresponding gear as indicated by the laser engraving arrow to achieve the required CCT and power conversion.
 3. Photocell: switchable photocell for dusk-to-dawn operation (on/off)
- 1) LJC-WL-8503-30D-277-S wall pack light Wattage Selectable: 30-40-50W, CCT Selectable: 3000K, 4000K, 5000K
Factory Setting: 50W, 5000K
- 2) LJC-WL-8803-30D-277-S wall pack light Wattage Selectable: 60-70-80W, CCT Selectable: 3000K, 4000K, 5000K
Factory Setting: 80W, 5000K

WARRANTY

This product is warranted for 5 years from the date of purchase. If this product does not perform to the specifications supplied on this package, send an email to us for product return and replacement. This replacement is the sole remedy available. Liability for incidental or consequential damage is expressly excluded.