



LED Lighting Product Manual

Make Light Wonderful





www.mwledlighting.com

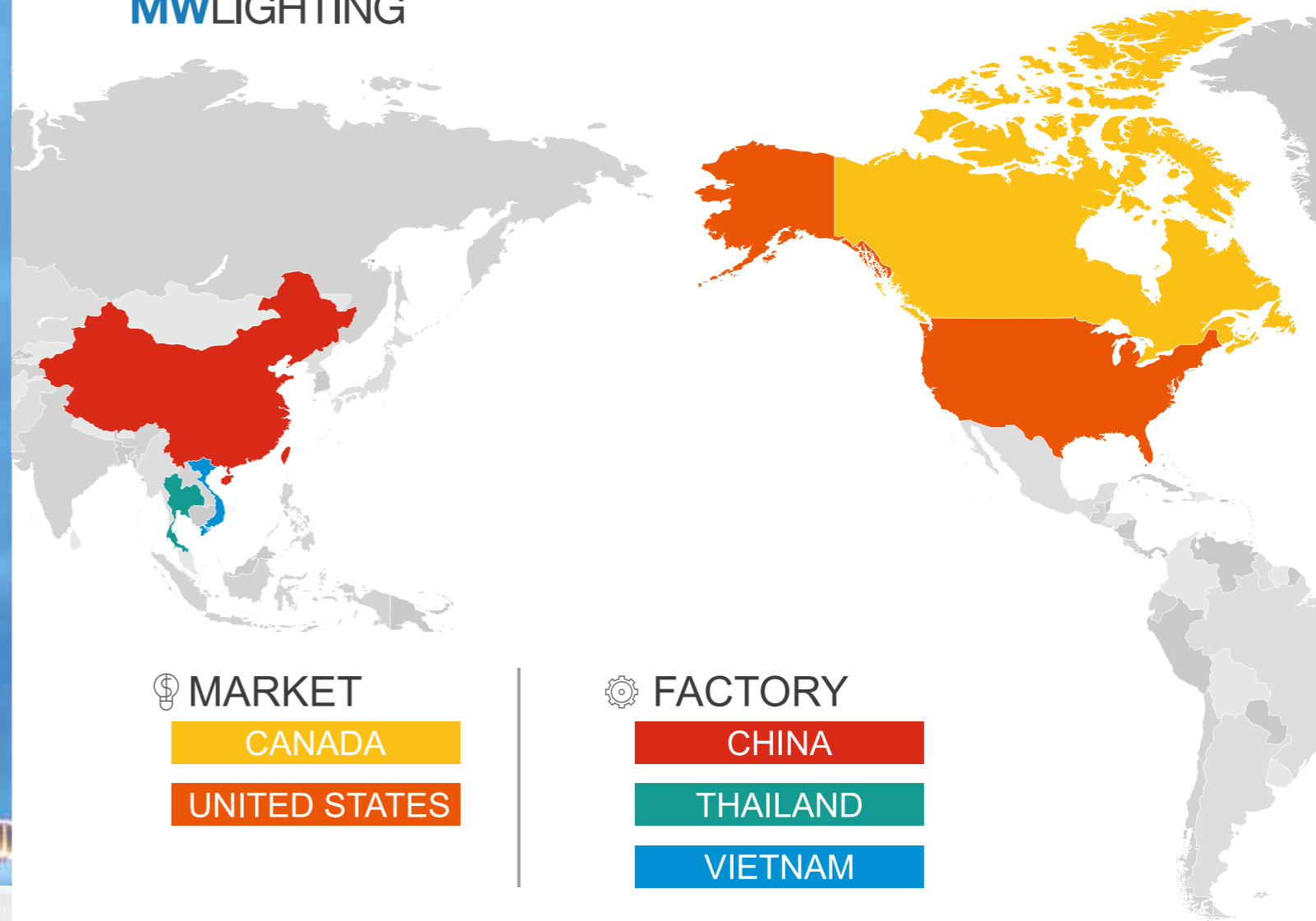

💡 MARKET

CANADA

UNITED STATES

⚙️ FACTORY

CHINA

THAILAND

VIETNAM

ABOUT US

- 🏢 California Based Company
- 💡 Focuses on developing modern and reliable lighting products
- 📄 Tested to comply with Industry standards
- ⚙️ Energy Star, UL and ETL rated
- 💎 Bring innovative, ultra-efficient, and best inclass lighting products

- Sales through distributors and sales rep
- USA distribution warehouse for drop shipping and technical support
- International team based in U.S.A, China, & Thailand

MW Lighting is a California-based company focused on developing highest-quality, modern, and reliable lighting products. Our products have been tested to comply with industry standards. At MW Lighting, we are committed to bringing innovative, ultra-efficient, best-in-class lighting solutions to our customers. By providing the service and products they deserve, we have established solid business relationships that have shaped who we are today. We have positioned MW Lighting to stay ahead of the market by focusing on timely innovation and delivering the highest quality product solutions to meet our partners' lighting needs. Our mission has always been to provide the latest quality products at reasonable prices to the lighting industry through our experience and technology.



01 LED Downlight Series

- Gimbal 5CCT Retrofit Downlight 03
- Round 5CCT Retrofit Downlight 04
- Square 5CCT Retrofit Downlight 05
- Eco Version 5CCT Retrofit Downlight 05
- Round 5CCT Black Retrofit Downlight 06
- Can-Less Deep Baffle 5CCT Downlight 07
- Can-Less Slim 5CCT Downlight 08
- Square Can-Less Slim 5CCT Downlight 10
- Gimbal/Swivel Can-Less 5CCT Downlight 12
- Floating Gimbal Can-Less 5CCT Downlight 14
- 4" Fire Rated Junction Box/Recessed Housing - 15
- Fire Rated Can-Less Downlight 16
- Fire Rated Recessed Housing 16
- IC-Rated Shallow Housing For New Construction --- 18
- IC-Rated Shallow Housing For Remodeling 18

02 Residential LED Fixtures

- 5CCT Trim-Less Light with Mud Ring 22
- 5CCT Trim-Less Light With Mounting Clips 22
- Surface Mount Disk Light 24
- Motion Sensor Surface Mount Disk Light 25
- Motion Sensor Surface Mount Downlight 25
- Surface Mount Fixture with Night Light 26
- Slim Flush Mount Ceiling Light 27
- 5CCT Slim Surface Mount Fixture 28
- Square 3CCT Slim Flush Mount Fixture 28
- 5CCT Double Ring Flush Mount Fixture 29
- 5CCT Surface Mount Fixture 30
- Up/Down Cylinder Wall Sconce 31
- LED Vanity Bath Light 32
- Split Bath Light Fixture 32
- Lens Adjustable Cabinet Light 33
- 3CCT Low Voltage Landscape Lights 35
- 2700K Low Voltage Landscape Lights 36
- 17" Vintage Farmhouse Pendant Light 37
- Modern Glass Semi Flush Mount Light 37
- 17" Black Farmhouse Pendant Light 38
- 4-Light Industrial Farmhouse Pendant Light ---- 38

03 Commercial LED Fixtures

- 3CCT Can-Less Commercial Downlight 41
- Modular Design Commercial Downlight 42
- 3CCT & Wattage Adjustable Wraparound Light --- 43
- 3CCT & Wattage Adjustable Backlit Panel Light --- 44
- 3CCT & Wattage Adjustable Troffer Light 45
- Beam Angle Adjustable LED High Bay Fixture ---- 46
- Single Panel LED Linear High Bay Fixture 47
- Twin Panel LED Linear High Bay Fixture 48
- Up/Down Linear Light Fixture 49
- 3CCT & Wattage Adjustable Strip Light 51
- 3CCT Strip Light with Emergency Driver 52
- Vapor Tight Fixture 53
- High Output Shoebox Area Light 54
- UFO High Bay Fixture 55
- 3CCT & Wattage Adjustable Flood Light 57
- 3CCT & Wattage Adjustable Wallpack Fixture ---- 58
- Mini Wallpack Fixture 58
- LED Exit Light 59
- USB Plus Type-C Outlet 62
- Duplex Wall Outlet 62
- GFCI Outlet 62
- Rocker Wall Switch 64
- Switch Wall Plate 64
- Switch and Outlet Box 66

04 Accessories

- High/Low Bay Motion Sensor 69
- Extension Cable 69
- Power Cable / Extension Cable 70
- Decorative Trim Ring 71
- Mount Plate 72
- Suspension Mount Kits 73
- Surface Mount Kits / Flange Kits 74
- UFO High Bay Accessories 76
- Emergency Driver 77
- Strip Light Chain 77

LED DOWNLIGHT SERIES

- Retrofit Downlight
- Can-less Downlight
- Fire Rated Series
- Recessed Housing



5CCT RETROFIT DOWNLIGHT

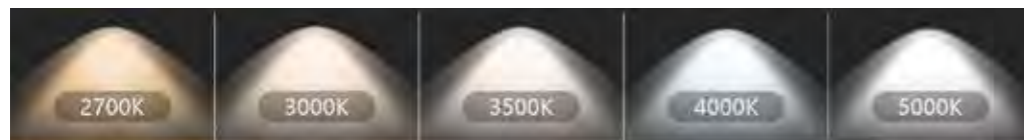

Lower color temperature looks warmer, making people feel welcome at home. Higher color temperature look cooler, creates a clean, crisp atmosphere for your work space. This product comes with a CCT switch which makes changing color much easier and convenient.

Gimbal 5CCT Retrofit Downlight

- 5 selectable color temperatures with 90+ CRI
- Fits standard recessed can housing
- 355-degree rotation and tilt up to 30 degrees
- Smooth dimming to 10%
- Suitable for IC and non-IC ceilings

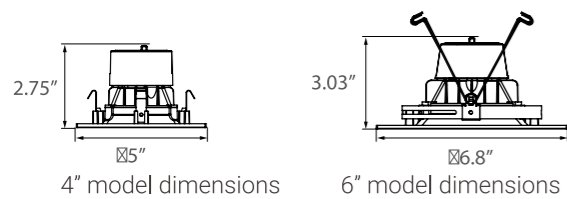

Model	Description	Brightness	Wattage	Efficacy	Color Temp.	CRI	Voltage	PF	Life
MRDAJ408-5CCT	4" Gimbal Downlight	750LM	8W	93Lm/W	5CCT-2700/3000/3500/4000/5000K	90+	120Vac 60Hz	≥0.9	50,000
MRDAJ611-5CCT	6" Gimbal Downlight	1100LM	11W	100Lm/W					

Round 5CCT Retrofit Downlight

- 5 selectable color temperatures with 90+ CRI
- Fits standard recessed can housing
- Aluminum body
- Smooth dimming to 10%
- Suitable for IC and non-IC ceilings

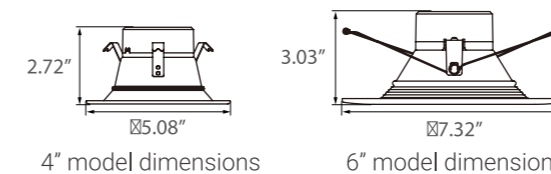

Model	Description	Brightness	Wattage	Efficacy	Color Temp.	CRI	Voltage	PF	Life
MRD410SM-5CCT	4" Smooth Trim Retrofit	750LM	10W	75Lm/W	5CCT	90+	120Vac 60Hz	≥0.9	50,000
MRD410BA-5CCT	4" Baffle Trim Retrofit	750LM	10W	75Lm/W	2700/3000/3500/4000/5000K				
MRD614SM-5CCT	6" Smooth Trim Retrofit	1100LM	14W	78.5Lm/W					
MRD614BA-5CCT	6" Baffle Trim Retrofit	1100LM	14W	78.5Lm/W					



Square 5CCT Retrofit Downlight

- 5 selectable color temperatures with 90+ CRI
- Fits standard recessed can housing
- Aluminum body
- Smooth dimming to 10%
- Suitable for IC and non-IC ceilings

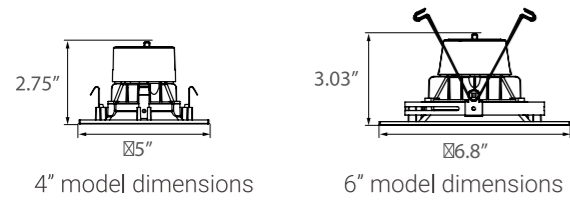

Model	Description	Brightness	Wattage	Efficacy	Color Temp.	CRI	Voltage	PF	Life
MSD411SM-5CCT	4", Smooth Trim Retrofit	750LM	11W	68Lm/W	5CCT-2700/3000/3500/4000/5000K	90+	120Vac 60Hz	≥0.9	50,000
MSD614SM-5CCT	6", Smooth Trim Retrofit	1100LM	14W	78.5Lm/W					



Eco Version Retrofit Downlight

- 4/6-inch Eco Version Retrofit Downlight
- Smooth Trim & Baffle Trim
- 5 selectable color temperatures with 90+ CRI
- Fits standard recessed can housing
- 120V smooth TRIAC dimming to 10%
- Suitable for use in IC and non-IC fixtures

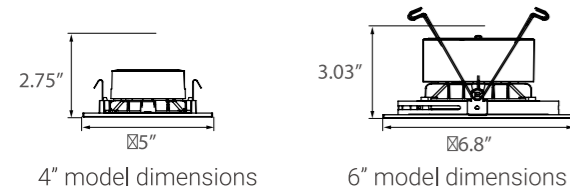

Model	Description	Brightness	Wattage	Efficacy	Color Temp.	CRI	Voltage	PF	Life
MERD409SM-5CCT	4" Economy Smooth Retrofit	750LM	9W	83Lm/W	5CCT-2700/3000/3500/4000/5000K	90+	120Vac 60Hz	≥0.9	50,000
MERD409BA-5CCT	4" Economy Baffle Retrofit	750LM	9W						
MERD612SM-5CCT	6" Economy Smooth Retrofit	1000LM	12W						
MERD612BA-5CCT	6" Economy Baffle Retrofit	1000LM	12W						

Round 5CCT Black Retrofit Downlight

- 5 selectable color temperatures with 90+ CRI
- Fits standard recessed can housing
- Aluminum body
- Smooth dimming to 10%
- Suitable for IC and non-IC ceilings

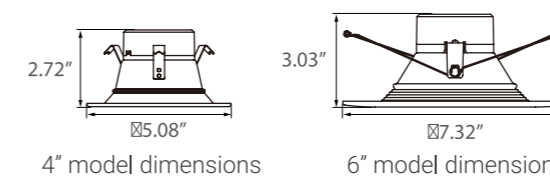

Model	Description	Brightness	Wattage	Efficacy	Color Temp.	CRI	Voltage	PF	Life
MRD410SM-5CCT-BK	4" Smooth Trim Retrofit	750LM	10W	75Lm/W	5CCT-2700/3000/3500/4000/5000K	90+	120Vac 60Hz	≥0.9	50,000
MRD410BA-5CCT-BK	4" Baffle Trim Retrofit	750LM	10W	75Lm/W					
MRD614SM-5CCT-BK	6" Smooth Trim Retrofit	1100LM	14W	78.5Lm/W					
MRD614BA-5CCT-BK	6" Baffle Trim Retrofit	1100LM	14W	78.5Lm/W					



CAN-LESS DOWNLIGHT

Can-less Deep Baffle 5CCT Downlight

- 5 selectable color temperatures with 90+ CRI
- Can-Less design, no recessed housing required
- Smooth dimming to 10%
- Aluminum body
- Suitable for IC and non-IC ceilings

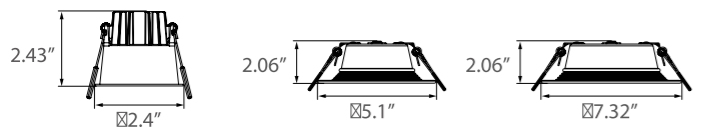

2" model dimensions 4" model dimensions 6" model dimensions

Model	Description	Brightness	Wattage	Efficacy	Color Temp.	CRI	Voltage	PF	Life
MRSD026W-DBA-5CCT-WH	2" Deep Baffle	370LM	6W	62Lm/W	5CCT - 2700/ 3000/ 3500/ 4000/ 5000K	90+	120Vac 60Hz	≥0.9	50,000
MRSD412W-DBA-5CCT-WH	4" Deep Baffle	750LM	12W	63Lm/W					
MRSD615W-DBA-5CCT-WH	6" Deep Baffle	1100LM	15W	75Lm/W					
MRSD412W-DBA-5CCT-WH-347V	4" Deep Baffle, 120-347v Input	750LM	12W	63Lm/W			120 to 347Vac 60Hz		
MRSD615W-DBA-5CCT-WH-347V	6" Deep Baffle, 120-347v Input	1100LM	15W	75Lm/W					



Round Can-less Slim 5CCT Downlight, Flat Trim

- 5 selectable color temperatures with 90+ CRI
- Ultra-Slim & Can-Less design for cramped and limited spaces
- Smooth dimming to 10%
- Aluminum body
- Junction box included
- Suitable for IC and non-IC ceilings

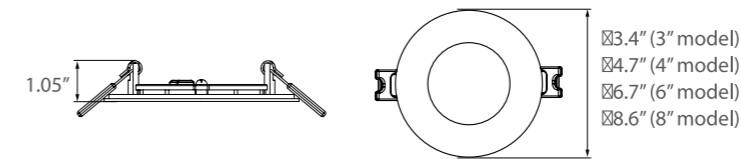

Model	Description	Brightness	Wattage	Efficacy	Color Temp.	CRI	Voltage	PF	Life
MRSD038W-5CCT	3", Flat Trim	500LM	8W	62.5Lm/W	5CCT - 2700/ 3000/ 3500/ 4000/ 5000K	90+	120Vac 60Hz	≥0.9	50,000
MRSD410W-5CCT	4", Flat Trim	650LM	10W	65Lm/W					
MRSD612W-5CCT	6", Flat Trim	900LM	12W	75Lm/W					
MRSD818W-5CCT	8", Flat Trim	1500LM	18W	83Lm/W					

Round Universal Input Can-less Slim 5CCT Downlight, Flat Trim

- 120 to 347Vac universal voltage input
- 5 selectable color temperatures with 90+ CRI
- Ultra-Slim & Can-Less design for cramped and limited spaces
- 0-10V smooth dimming to 10%
- Aluminum body
- Junction box included
- Suitable for IC and non-IC ceilings

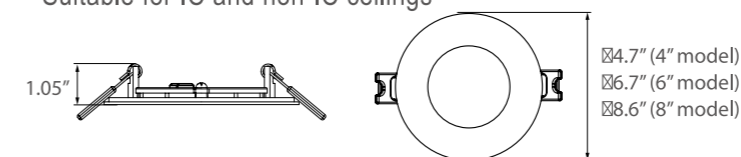

Model	Description	Brightness	Wattage	Efficacy	Color Temp.	CRI	Voltage	PF	Life
MRSD410W-5CCT-347V	4", Flat Trim, 120-347v Input	650LM	10W	65Lm/W	5CCT - 2700/ 3000/ 3500/ 4000/ 5000K	90+	120to 347Vac 60Hz	≥0.9	50,000
MRSD612W-5CCT-347V	6", Flat Trim, 120-347v Input	900LM	12W	75Lm/W					
MRSD818W-5CCT-347V	8" Flat Trim, 120-347v Input	1500LM	18W	83Lm/W					



Round Can-less Slim 5CCT Downlight, Baffle Trim

- 5 selectable color temperatures with 90+ CRI
- Ultra-Slim & Can-Less design for cramped and limited spaces
- Smooth dimming to 10%
- Aluminum body
- Junction box included
- Suitable for IC and non-IC ceilings

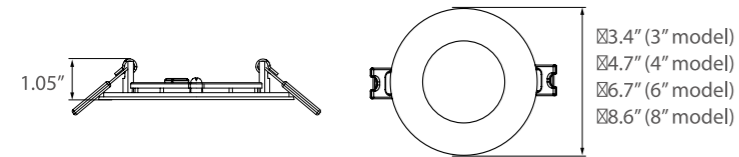

Model	Description	Brightness	Wattage	Efficacy	Color Temp.	CRI	Voltage	PF	Life
MRSD038WBA-5CCT	3", Baffle Trim	500LM	10W	62.5Lm/W	5CCT	90+	120Vac 60Hz	≥0.9	50,000
MRSD410WBA-5CCT	4", Baffle Trim	650LM	10W	65Lm/W	2700/3000/3500/4000/5000K				
MRSD612WBA-5CCT	6", Baffle Trim	900LM	12W	75Lm/W					
MRSD818WBA-5CCT	8", Baffle Trim	1500LM	18W	83Lm/W					

Round Universal Input Can-less Slim 5CCT Downlight, Baffle Trim

- 120 to 347Vac universal voltage input
- 5 selectable color temperatures with 90+ CRI
- Ultra-Slim & Can-Less design for cramped and limited spaces
- 0-10V Smooth dimming to 10%
- Aluminum body
- Junction box included
- Suitable for IC and non-IC ceilings

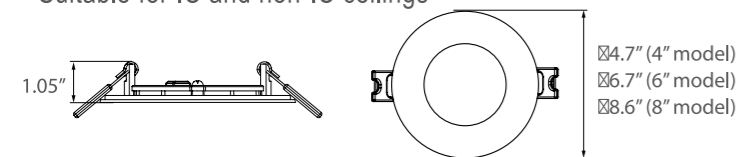

Model	Description	Brightness	Wattage	Efficacy	Color Temp.	CRI	Voltage	PF	Life
MRSD410WBA-5CCT-347V	4", Baffle Trim, 120-347v Input	650LM	10W	65Lm/W	5CCT-2700/3000/3500/4000/5000K	90+	120 to 347Vac 60Hz	≥0.9	50,000
MRSD612WBA-5CCT-347V	6", Baffle Trim, 120-347v Input	900LM	12W	75Lm/W					
MRSD818WBA-5CCT-347V	8", Baffle Trim, 120-347v Input	1500LM	18W	83Lm/W					

Square Can-less Slim 5CCT Downlight, Flat Trim

- 5 selectable color temperatures with 90+ CRI
- Ultra-Slim & Can-Less design for cramped and limited spaces
- Smooth dimming to 10%
- Aluminum body
- Junction box included
- Suitable for IC and non-IC ceilings

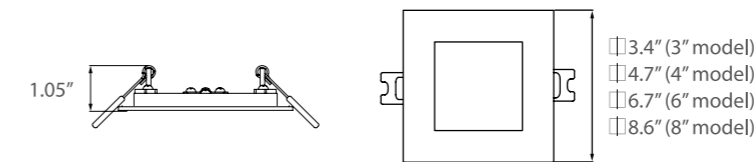

Model	Description	Brightness	Wattage	Efficacy	Color Temp.	CRI	Voltage	PF	Life
MSSD038W-5CCT	3", Flat Trim	500LM	8W	62.5Lm/W	5CCT	90+	120Vac 60Hz	≥0.9	50,000
MSSD410W-5CCT	4", Flat Trim	650LM	10W	65Lm/W	2700/3000/3500/4000/5000K				
MSSD615W-5CCT	6", Flat Trim	1100LM	15W	73Lm/W					
MSSD818W-5CCT	8", Flat Trim	1500LM	18W	83Lm/W					

Square Universal Input Can-less Slim 5CCT Downlight, Flat Trim

- 120 to 347Vac universal voltage input
- 5 selectable color temperatures with 90+ CRI
- Ultra-Slim & Can-Less design for cramped and limited spaces
- 0-10V Smooth dimming to 10%
- Aluminum body
- Junction box included
- Suitable for IC and non-IC ceilings

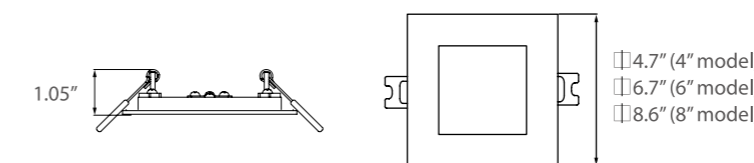

Model	Description	Brightness	Wattage	Efficacy	Color Temp.	CRI	Voltage	PF	Life
MSSD410W-5CCT-347V	4", Flat Trim, 120-347v Input	650LM	10W	65Lm/W	5CCT-2700/3000/3500/4000/5000K	90+	120 to 347Vac 60Hz	≥0.9	50,000
MSSD615W-5CCT-347V	6", Flat Trim, 120-347v Input	1100LM	15W	73Lm/W					
MSSD818W-5CCT-347V	8", Flat Trim, 120-347v Input	1500LM	18W	83Lm/W					



Square Can-less Slim 5CCT Downlight, Baffle Trim

- 5 selectable color temperatures with 90+ CRI
- Ultra-Slim & Can-Less design for cramped and limited spaces
- Smooth dimming to 10%
- Aluminum body
- Junction box included
- Suitable for IC and non-IC ceilings

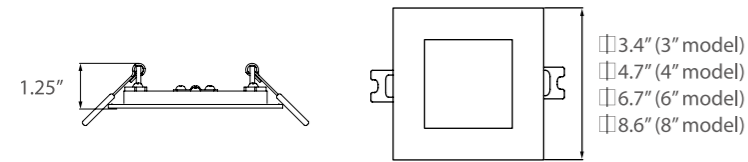

Model	Description	Brightness	Wattage	Efficacy	Color Temp.	CRI	Voltage	PF	Life
MSSD038WBA-5CCT	3", Baffle Trim	500LM	8W	62.5Lm/W	5CCT	90+	120Vac 60Hz	≥0.9	50,000
MSSD410WBA-5CCT	4", Baffle Trim	650LM	10W	65L m/W	2700/ 3000/ 3500/ 4000/ 5000K				
MSSD615WBA-5CCT	6", Baffle Trim	1100LM	15W	73Lm/W					
MSSD818WBA-5CCT	8", Baffle Trim	1500LM	18W	83Lm/W					

Gimbal Can-Less 5CCT Downlight

- 5 selectable color temperatures with 90+ CRI
- Can-Less, no recessed housing required for installation
- Tilt up to 20 degree
- Smooth dimming to 10%
- Aluminum body, junction box included
- Suitable for IC and non-IC ceilings

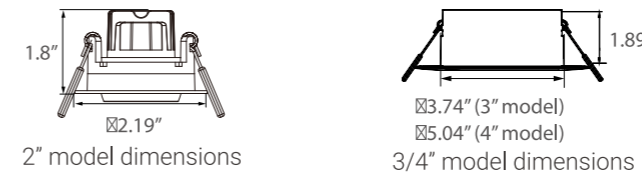

Model	Description	Brightness	Wattage	Efficacy	Color Temp.	CRI	Voltage	PF	Life
MGD026W-5CCT	2" 5CCT can-less gimbal downlight	360LM	6W	60Lm/W	5CCT	90+	120Vac 60Hz	≥0.9	50,000
MGD036W-5CCT	3" 5CCT can-less gimbal downlight	370LM	6W	62Lm/W	2700/ 3000/ 3500/ 4000/ 5000K				
MGD049W-5CCT	4" 5CCT can-less gimbal downlight	540LM	9W	62Lm/W					

Square Universal Input Can-less Slim 5CCT Downlight, Baffle Trim

- 120 to 347Vac universal voltage input
- 5 selectable color temperatures with 90+ CRI
- Ultra-Slim & Can-Less design for cramped and limited spaces
- 0-10V smooth dimming to 10%
- Aluminum body
- Junction box included
- Suitable for IC and non-IC ceilings

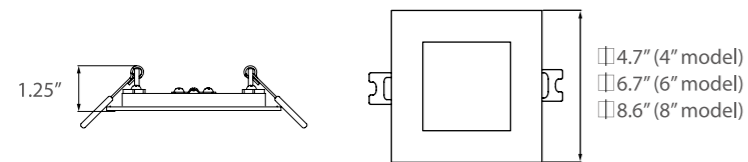

Model	Description	Brightness	Wattage	Efficacy	Color Temp.	CRI	Voltage	PF	Life
MSSD410WBA-5CCT-347V	4", Baffle Trim, 120-347v Input	650LM	10W	65Lm/W	5CCT- 2700/ 3000/ 3500/ 4000/ 5000K	90+	120 to 347Vac 60Hz	≥0.9	50,000
MSSD615WBA-5CCT-347V	6", Baffle Trim, 120-347v Input	1100LM	15W	73Lm/W					
MSSD818WBA-5CCT-347V	8", Baffle Trim, 120-347v Input	1500LM	18W	83Lm/W					

Swivel Can-Less 5CCT Downlight

- 5 selectable color temperatures with 90+ CRI
- Can-Less, no recessed housing required for installation
- Tilt up to 20 degree
- Smooth dimming to 10%
- Aluminum body, junction box included
- Suitable for IC and non-IC ceilings

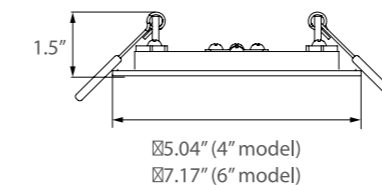

Model	Description	Brightness	Wattage	Efficacy	Color Temp.	CRI	Voltage	PF	Life
MGD049W-TNW-5CCT	4" Swivel Downlight	540LM	9W	60Lm/W	5CCT- 2700/ 3000/ 3500/ 4000/ 5000K	90+	120 to - 60Hz	≥0.9	50,000
MGD612W-TNW-5CCT	6" Swivel Downlight	800LM	12W	66Lm/W					
MGD612W-TNW-5CCT-347V	6" Swivel Downlight, 120-347V Input	800LM	12W	66Lm/W					



Flood Floating Gimbal Can-less 5CCT Downlight

- Large coverage area compared to spot-floating gimbal downlights
- 5 selectable color temperatures with 90+ CRI
- Can-Less, no recessed housing required for installation
- 355-degree rotation and tilt up to 85 degrees
- Smooth dimming to 10%
- Aluminum box, junction box included
- Suitable for IC and non-IC ceilings



1.5" (4" model)
2.0" (6" model)

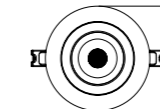
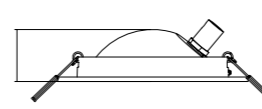

Ø5.04" (4" model)
Ø7.20" (6" model)

Model	Description	Brightness	Wattage	Efficacy	Color Temp.	CRI	Voltage	PF	Life
MFGD049-FL-5CCT-WH	4" Flood Floating Gimbal Downlight	540LM	9W	60Lm/W	5CCT-2700/ 3000/3500/ 4000/5000K	90+	120Vac 60Hz	≥0.9	50,000
MFGD612-FL-5CCT-WH	6" Flood Floating Gimbal Downlight	950LM	12W	75Lm/W					

Spot Floating Gimbal Can-less 5CCT Downlight

- Spot lighting effect for highlighting objects
- 5 selectable color temperatures with 90+ CRI
- Can-Less, no recessed housing required for installation
- 355-degree rotation and tilt up to 85 degrees
- Smooth dimming to 10%
- Aluminum body, junction box included
- Suitable for IC and non-IC ceilings



1.22" (3" model)
1.50" (4" model)

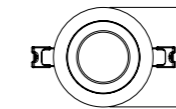
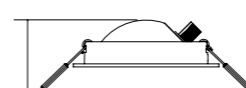

Ø3.78" (3" model)
Ø5.04" (4" model)

Model	Description	Brightness	Wattage	Efficacy	Color Temp.	CRI	Voltage	PF	Life
MFGD036-SP-5CCT-WH	3" Spot Floating Gimbal Downlight	345LM	6W	57.5Lm/W	5CCT-2700/ 3000/3500/ 4000/5000K	90+	120Vac 60Hz	≥0.9	50,000
MFGD049-SP-5CCT-WH	4" Spot Floating Gimbal Downlight	540LM	9W	60Lm/W					



FIRE RATED DOWNLIGHT

Fire Resistant Junction Box & Recessed Housing Can

- Suitable for Wet Location
- Air Tight
- Suitable for recessed fixtures



Model	Description	Certificate
MFR4	4" Fire Resistant Junction Box/Recessed Housing Can	ETL, title 24
MFR4-RH	4" Fire Resistant Recessed Housing Can	
MFR6-RH	6" Fire Resistant Recessed Housing Can	



Fire Rated Can-less Downlight

- 2 hours fire resistant
- Suitable for Wet Location
- 5 selectable color temperatures, 90+ CRI
- Ultra-Slim design for cramped and limited spaces
- Can-Less, no recessed housing required for installation
- Smooth dimming to 10%
- Junction box included
- Suitable for IC and non-IC ceilings

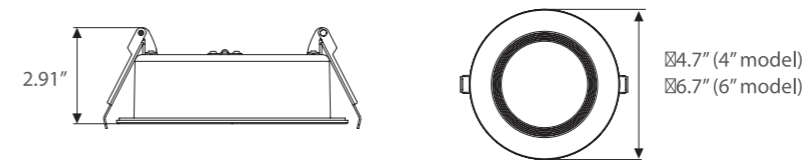

Model	Description	Brightness	Wattage	Efficacy	Color Temp.	CRI	Voltage	PF	Life
MRFR410W-FL-5CCT	4" Can-less Fire Rated Downlight, Flat Trim	800LM	10W	80Lm/W	5CCT - 2700/ 3000/ 3500/ 4000/ 5000K	90+	120Vac 60Hz	≥0.9	50,000
MRFR410W-SM-5CCT	4" Can-less Fire Rated Downlight, Smooth Trim	800LM	10W	80Lm/W					
MRFR410W-BA-5CCT	4" Can-less Fire Rated Downlight, Baffle Trim	800LM	10W	80Lm/W					
MRFR615W-FL-5CCT	6" Can-less Fire Rated Downlight, Flat Trim	1100LM	15W	73Lm/W					
MRFR615W-SM-5CCT	6" Can-less Fire Rated Downlight, Smooth Trim	1100LM	15W	73Lm/W					
MRFR615W-BA-5CCT	6" Can-less Fire Rated Downlight, Baffle Trim	1100LM	15W	73Lm/W					

Fire Rated Junction Box

- Suitable for Wet Location
- Suitable for recessed fixtures
- AirTight
- Conforms to UL1598 Recessed Luminaire Housing rated IC
- Conforms to UL514A Metallic Outlet Box, fire rated up to 2 hours





RECESSED HOUSING CAN

IC-Type Shallow Housing Can For New Construction

- IC-rated for direct insulation contact
- Extendable hanger bars with nails included
- Quick wiring connectors included; no wiring nuts or electrical tape needed for wiring
- Suitable for ceiling joist installations and drop ceiling installations
- Eight conduit knockouts for convenient wiring

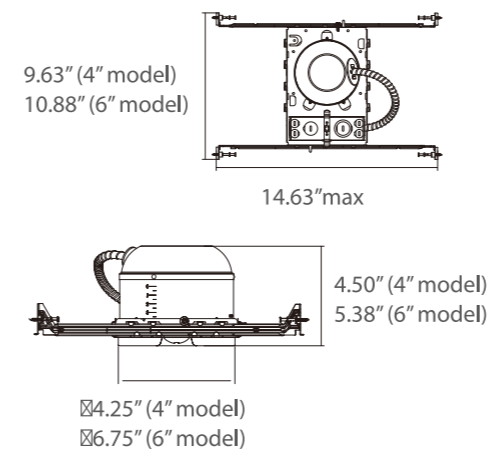

IC-Type Shallow Housing Can For Remodeling

- IC-rated for direct insulation contact
- ETL listed for damp locations
- Suitable for remodels with shallow ceilings
- Quick wiring connectors included for easier wiring; no wiring nuts or electrical tape needed.
- Aluminum housing with junction box included
- Two conduit knockouts for convenient wiring

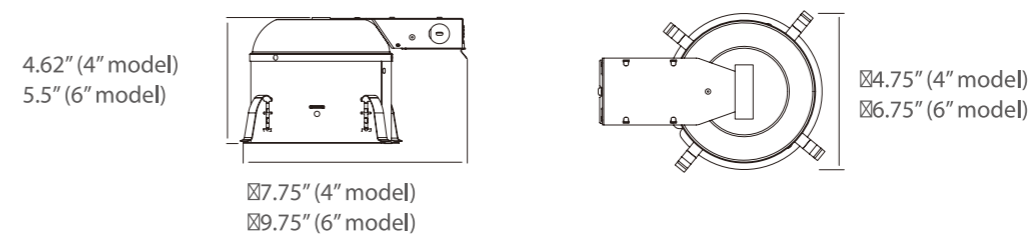

RESIDENTIAL LED FIXTURES

- Trim-less Recessed Light
- Surface Mount Fixture
- Bath Light
- LED Landscape Light
- Disk Light
- Cylinder Light
- Cabinet Light
- Decorative Lamp

Trim-less 5CCT Recessed Light With Mud Ring

- 5 selectable color temperatures
- Canless design, no housing cans needed
- Smooth dimming to 10%
- Power Supply / Junction Box included
- Cast aluminum body
- 90+ CRI



Ø3.5" (1" model)
 Ø4.25" (2" model)
 Ø5.1" (3" model)

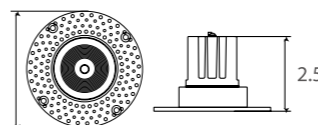

Model	Description	Brightness	Wattage	Efficacy	Color Temp.	CRI	Voltage	PF	Life
MRHD109W-TL-5CCT-WH	1" Trim-less Downlight With Mud Ring	600LM	9W	66Lm/W	5CCT-2700/3000/3500/4000/5000K	90+	120Vac 60Hz	≥0.9	50,000
MRHD213W-TL-5CCT-WH	2" Trim-less Downlight With Mud Ring	750LM	13W	58Lm/W					
MRHD315W-TL-5CCT-WH	3" Trim-less Downlight With Mud Ring	900LM	15W	60Lm/W					

Trim-less 5CCT Recessed Light With Spring Mount Clips

- 5 selectable color temperatures
- Canless design, no housing cans needed
- Smooth dimming to 10%
- Power Supply / Junction Box included
- Cast aluminum body
- 90+ CRI

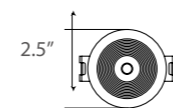

Ø1.25" (1" model)
 Ø2.69" (2" model)
 Ø3.25" (3" model)

Model	Description	Brightness	Wattage	Efficacy	Color Temp.	CRI	Voltage	PF	Life
MRHD0109W-SM-5CCT-WH	1" Trim-less Downlight	600LM	9W	66Lm/W	5CCT-2700/3000/3500/4000/5000K	90+	120Vac 60Hz	≥0.9	50,000
MRHD0213W-SM-5CCT-WH	2" Trim-less Downlight	800LM	13W	58Lm/W					
MRHD0315W-SM-5CCT-WH	3" Trim-less Downlight	950LM	15W	60Lm/W					

Characterized by their seamless design that integrates smoothly into the ceiling, the trim-less downlights create a clean and modern appearance. The absence of visible trims or bezels ensures a sleek and unobtrusive look, making them ideal for contemporary interior designs.

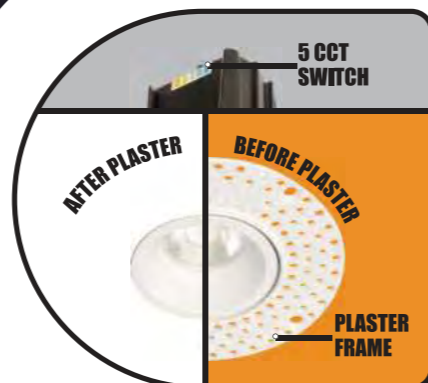



Surface Mount Disk Light

- Surface mount to junction box, no housing cans needed
- Suitable for wet locations
- Suitable for IC and non-IC ceilings



2.12" (4" model)
1.57" (6" model)
1.75" (8" model)
2.22" (12" model)

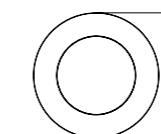

Ø6.25" (4" model)
Ø7.48" (6" model)
Ø9.37" (8" model)
Ø13" (12" model)

Model	Description	Brightness	Wattage	Efficacy	Color Temp.	CRI	Voltage	PF	Life
MDD412W-5CCT	4" 5CCT surface mount disk light	840Lm	12W	70Lm/W	5CCT - 2700/ 3000/ 3500/ 4000/ 5000K	90+	120Vac 60Hz	≥0.9	50,000
MDD615W-5CCT	6" 5CCT surface mount disk light	1050Lm	15W	70Lm/W					
MDD818W-5CCT	8" 5CCT surface mount disk light	1260Lm	18W	70Lm/W					
MDD1225W-5CCT	12" 5CCT surface mount disk light	1750Lm	25W	70Lm/W					
MDDE412W-5CCT	4" eco 5CCT surface mount disk light	650Lm	10W	65Lm/W					
MDDE616W-5CCT	6" eco 5CCT surface mount disk light	1050Lm	16W	65Lm/W					
MDD615W-30K-WH	6" surface mount disk light	1050Lm	15W	70Lm/W	3000K				

Disk Light

Surface Mount

The surface mounting design allows this disk light to be installed in any location close to a junction box. Particularly suitable for mounting on ceilings in porches, hallways, and staircases.

Surface Mount Disk Light With Motion Sensor

- Surface mount
- Suitable for IC and non-IC ceilings
- Built-in motion sensor, detect range up to 15ft
- CRI 90+
- Suitable for wet locations

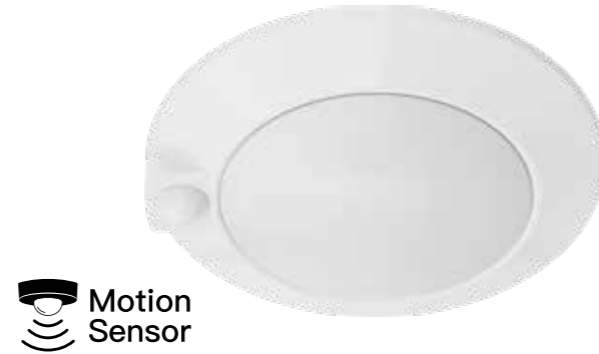
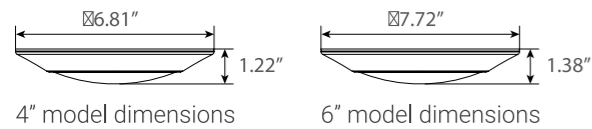

Model	Description	Brightness	Wattage	Efficacy	Color Temp.	CRI	Voltage	PF	Life
MDDS410-30K-WH	4" surface mount disk light with motion sensor	650LM	10W	65Lm/W	3000K	90+	120Vac 60Hz	≥0.9	50,000
MDDS614-30K-WH	6" surface mount disk light with motion sensor	950LM	14W	68Lm/W					

Surface Mount DownLight With Motion Sensor

- Surface mount
- Suitable for IC and non-IC ceilings
- Built-in motion sensor, detect range up to 15ft
- CRI 90+
- Suitable for wet locations

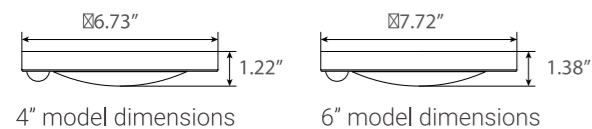

Model	Description	Brightness	Wattage	Efficacy	Color Temp.	CRI	Voltage	PF	Life
MRSMMMS410-30K-WH	4" surface mount disk light with motion sensor	650LM	10W	65Lm/W	3000K	90+	120Vac 60Hz	≥0.9	50,000
MRSMMMS614-30K-WH	6" surface mount disk light with motion sensor	950LM	14W	68Lm/W					



15 Ft Detect Range

The motion sensor enables this disk light to automatically illuminate only when motion is detected, providing efficient energy savings.



SURFACE MOUNT FIXTURE

Surface Mount Fixture With Night Light

- Elevate your lighting experience with our versatile surface mount fixture featuring a unique integrated night light. With 5CCT selectable options, you can effortlessly adjust the color temperature to your preference using the switch discreetly located on the back.
- This innovative surface mount fixture also includes a built-in night light, providing gentle and smooth illumination during nighttime hours.
- Designed for convenience and style, installation is simple—just mount it onto a standard junction box. Enhance your space with both functional and ambient lighting in one sleek design.



Model	Description	Brightness	Wattage	Efficacy	ColorTemp.	CRI	Voltage	PF	Life
MRFM-BL-715-5CCT	7" Surface mount with back light	1040LM	12W	86Lm/W	5CCT-2700/3000/3500/4000/5000K	90+	120Vac 60Hz	≥0.9	50,000
MRFM-BL-1227-5CCT	12" Surface mount with back light	1680LM	24W	70Lm/W					



5CCT Slim Surface Mount Fixture

- 5 selectable color temperatures with 90+ CRI
- Smooth dimming to 10%
- Aluminum housing with steel back plate

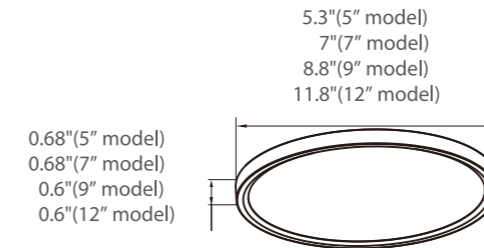

Model	Description	Brightness	Wattage	Efficacy	Color Temp.	CRI	Voltage	PF	Life
MRFM511-5CCT	5" Flush mount ceiling light	700LM	11W	63Lm/W	5CCT-2700/ 3000/ 3500/ 4000/ 5000K	90+	120Vac 60Hz	≥0.9	50,000
MRFM714-5CCT	7" Flush mount ceiling light	960LM	14W	68Lm/W					
MRFM920-5CCT	9" Flush mount ceiling light	1400LM	20W	70Lm/W					
MRFM1225-5CCT	12" Flush mount ceiling light	2000LM	25W	80Lm/W					

Semi-Flush Mount Ceiling Light

- Introducing our versatile 5CCT Surface Mount Light Fixture, available in both square and round designs. This fixture offers multiple installation options, functioning as either a pendant light or a flush mount fixture. Choose the shape and installation method that best suits your space.
- Enjoy the flexibility of 5 selectable color temperatures, ranging from warm white to daylight, allowing you to easily adjust the lighting ambiance to your preference. Whether for residential, office, or commercial spaces, this light fixture provides the perfect lighting solution. Elevate your space with our innovative and customizable 5CCT Surface Mount Light Fixture.

Surface Mount Kits is Included

Pendant Mount:
Hang devices from the ceiling using rods or chains. Great for large lights or surveillance equipment, especially when specific areas need focused illumination or monitoring. Adds visual depth and avoids wall interference.

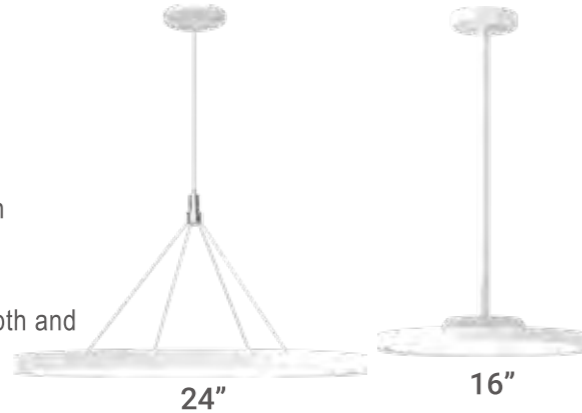

Install devices on poles, often outdoors. Useful for lights or surveillance equipment, especially in public areas. Improves visibility and can be adjusted for different needs. Polesize: 12", 24", 36", 48".

Model	Description	Brightness	Wattage	Efficacy	ColorTemp.	CRI	Voltage	PF	Life
MRFM1630-5CCT	16" Flush mount ceiling light	1950LM	30W	65Lm/W	5CCT-2700/3000/ 3500/4000/ 5000K	90+	120Vac 60Hz	≥0.9	50,000
MRFM2430-5CCT	24" Flush mount ceiling light	3360LM	48W	70Lm/W					

Square 3CCT Slim Flush Mount Fixture

- 3 selectable color temperatures with 90+ CRI
- Smooth dimming to 10%
- Aluminum body, steel back plate

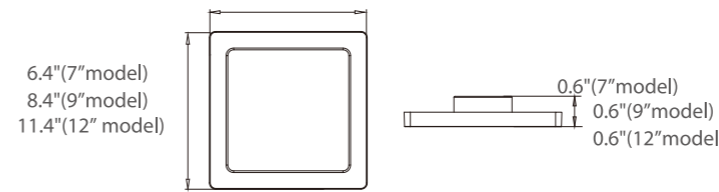

Model	Description	Brightness	Wattage	Efficacy	Color Temp.	CRI	Voltage	PF	Life
MSFM712-3CCT	7" Square Flush mount ceiling light	580LM	10.5W	55.5Lm/W	3CCT-3000/ 4000/ 5000K	90+	120Vac 60Hz	≥0.9	50,000
MSFM918-3CCT	9" Square Flush mount ceiling light	800LM	13.5W	56Lm/W					
MSFM1224-3CCT	12" Square Flush mount ceiling light	1050LM	18.5W	57Lm/W					



5CCT Surface Mount Fixture

- 5 selectable color temperatures with 90+ CRI
- Surface mount to junction box, no housing cans needed.
- Smooth dimming to 10%
- Aluminum body with steel back plate
- Available in pure white, brush nickel and bronze finish

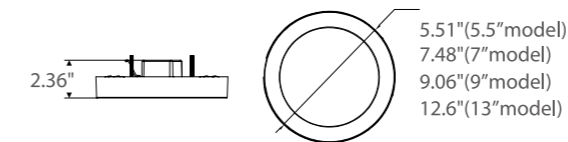

Model	Description	Brightness	Wattage	Efficacy	Color Temp.	CRI	Voltage	PF	Life
MRSM510-5CCT	5.5" Surface Mount Fixture	580LM	10.5W	55.5Lm/W	5CCT-2700/3000/3500/4000/5000K	90+	120Vac 60Hz	≥0.9	50,000
MRSM713-5CCT	7" Surface Mount Fixture	750LM	13.5W	56Lm/W					
MRSM918-5CCT	9" Surface Mount Fixture	1050LM	18.5W	57Lm/W					
MRSM1325-5CCT	13" Surface Mount Fixture	1375LM	25W	55Lm/W					

5CCT Double Ring Flush Mount Fixture

- 5 selectable color temperatures
- Smooth flicker free dimming down to 10%
- Metal trim with brush nickel finish
- Steel back plate
- High quality PC lens
- Efficiency LED array
- Diffuse for uniform illumination

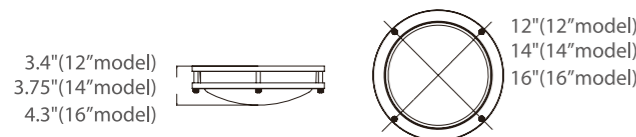

Model	Description	Brightness	Wattage	Efficacy	Color Temp.	CRI	Voltage	PF	Life
IP-DR12-15W5CCT	12" 5cct Double Ring Flush Mount	1000LM	15W	66Lm/W	5CCT-2700/3000/3500/4000/5000K	80+	120Vac 60Hz	≥0.9	50,000
IP-DR14-21W5CCT	14" 5cct Double Ring Flush Mount	1600LM	21W	76Lm/W					
IP-DR16-24W5CCT	16" 5cct Double Ring Flush Mount	1900LM	24W	79Lm/W					

Square 5CCT Surface Mount Fixture

- 5 selectable color temperatures with 90+ CRI
- Surface mount to junction box, no housing cans needed
- Smooth dimming to 10%
- Aluminum body, steel back plate
- Available in pure white, brush nickel and bronze finish

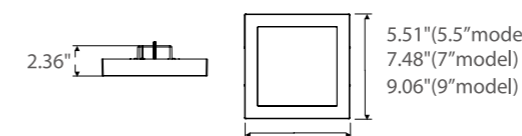

Model	Description	Brightness	Wattage	Efficacy	Color Temp.	CRI	Voltage	PF	Life
MSSM510-5CCT	5.5" Surface Mount Fixture	580LM	10.5W	55.5Lm/W	5CCT-2700/3000/3500/4000/5000K	90+	120Vac 60Hz	≥0.9	50,000
MSSM713-5CCT	7" Surface Mount Fixture	750LM	13.5W	56Lm/W					
MSSM918-5CCT	9" Surface Mount Fixture	1050LM	18.5W	57Lm/W					

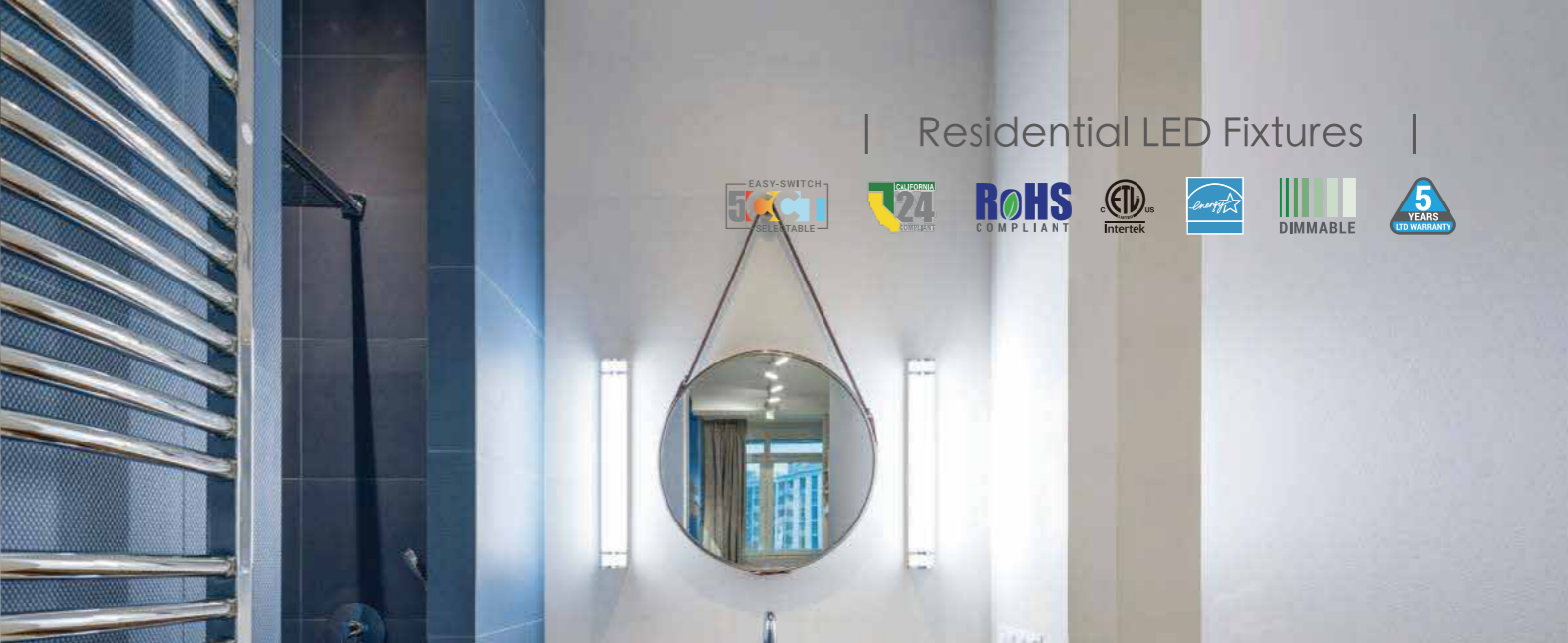

CYLINDER LIGHT

LED Vanity Bath Light

- Die-formed cold-rolled steel with powder coated paint
- High transmission white acrylic lens with satin nickel trim
- Smooth TRIAC dimming
- 140° beam angle even lighting distribution.
- Ambient temperature: -4° to 104°F



Up/Down Cylinder Wall Sconce

- Aluminum body
- Waterproof, suitable for outdoor usage
- Smooth TRIAC dimming
- 95° beam angle even lighting distribution
- Ambient temperature: -4° to 104°F

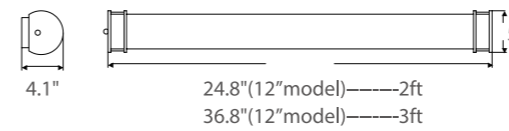
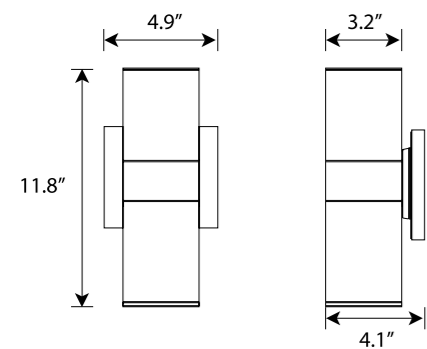

Model	Description	Brightness	Wattage	Efficacy	Color Temp.	CRI	Voltage	PF	Life
MWVL2FT25W-3CCT	2' LED Vanity Bath Light Fixture	1750LM	25W	70Lm/W	3CCT-3000/4000/5000K	90+	120Vac 60Hz	≥0.9	50,000
MWVL3FT36W-3CCT	3' LED Vanity Bath Light Fixture	3060LM	36W	85Lm/W					

Model	Description	Brightness	Wattage	Efficacy	Color Temp.	CRI	Voltage	PF	Life
MCYLUD20WWH-30K	Led Wall Light, White Finish	1400LM (700Lm+700Lm)	20W	70Lm/W	3000K	80+	120Vac 60Hz	≥0.9	50,000
MCYLUD20WBK-30K	Led Wall Light, Black Finish								

Split Bath Light Fixture

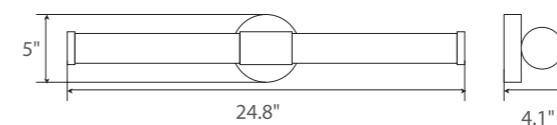

Model	Description	Brightness	Wattage	Efficacy	Color Temp.	CRI	Voltage	PF	Life
MWVLR2FT25W-3CCT-BN	2' LED Split Bath Light Fixture	1750LM	25W	70Lm/W	3CCT-3000/4000/5000K	80+	120Vac 60Hz	≥0.9	50,000

CABINET LIGHT

Lens Adjustable Cabinet Light

- Elevate your cabinet lighting with our innovative 5CCT Lens Adjustable Cabinet Light. Crafted with a durable metal housing, this fixture is designed to stand the test of time. The convenient 5CCT switch allows you to easily customize the lighting, offering a range of warm to cool hues. Its adjustable lens enables precise light direction, combining practicality with aesthetic appeal.
- Versatile and convenient, this cabinet light is linkable, allowing multiple fixtures to connect for a seamless, cohesive lighting solution. Illuminate your space with the perfect blend of style, flexibility, and functionality—all in one compact package. Upgrade your cabinet lighting today with our 5CCT Lens Adjustable Cabinet Light and enjoy a fully customized lighting experience.

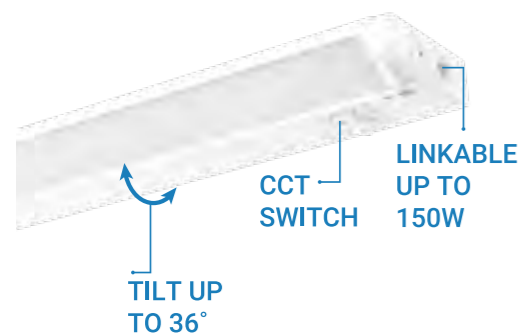

The lens of this 5CCT cabinet light can be adjusted up to 36 degrees, providing easy beam direction for targeted illumination. Connect up to 150W of additional fixtures for a flexible and adaptable lighting solution. Customize your lighting with 5 selectable color temperatures, ensuring the perfect ambiance for any space.

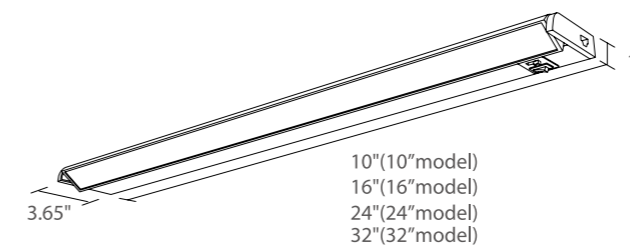

- 5 selectable color temperatures
- Linkable up to 150W
- Lens swivel angle up to 36°
- Hardwire or power cord to connect
- Metal housing
- 90+ CRI

Model	Description	Brightness	Wattage	Efficacy	Color Temp.	CRI	Voltage	PF	Life
MUCAD10-7W-5CCT-WH	10" Cabinet Light	385LM	7W	55Lm/W	5CCT-2700/3000/3500/4000/5000K	90+	120Vac 60Hz	≥0.9	50,000
MUCAD16-11W-5CCT-WH	16" Cabinet Light	620LM	11W	56Lm/W					
MUCAD24-15W-5CCT-WH	24" Cabinet Light	925LM	15W	62Lm/W					
MUCAD32-17W-5CCT-WH	32" Cabinet Light	1050LM	16.5W	63Lm/W					



LED LANDSCAPE LIGHT

3CCT Low Voltage Landscape Spot Light

- 12V-24V AC/DC Low voltage landscape light
- Durable die-cast aluminum for outdoor use
- 3CCT selectable
- 45° narrow beam angle
- Suitable for wet location
- 90+ CRI

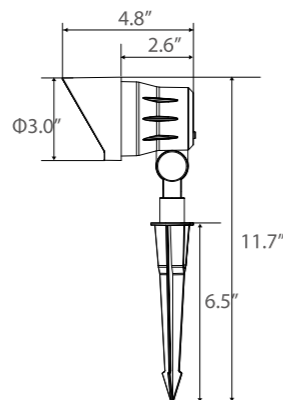

Model	Description	Brightness	Wattage	Efficacy	Color Temp.	Beam Angel(°)	CRI	Voltage	PF	Life
MLS-GPLX-11	Spot Light Landscape	164LM	4W	41Lm/W	3CCT-2700/3000/4000K	45° Narrow Beam Angle	90+	120Vac 60Hz	≥0.9	50,000

2700K Low Voltage Landscape Pathway Light

- 12V-24V AC/DC Low voltage landscape light
- Linkable up to 150w
- Light angle up to 360°
- Hardwire or power cord to connect
- Durable die-cast aluminum for outdoor use
- 90+ CRI
- Suitable for wet location

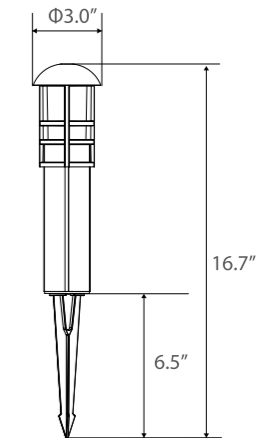

Model	Description	Brightness	Wattage	Color Temp.	CRI	Voltage	PF	Life
MLS-GPLM-11	Pathway Light Landscape	90LM	3W	2700K	90+	120Vac 60Hz	≥0.9	50,000

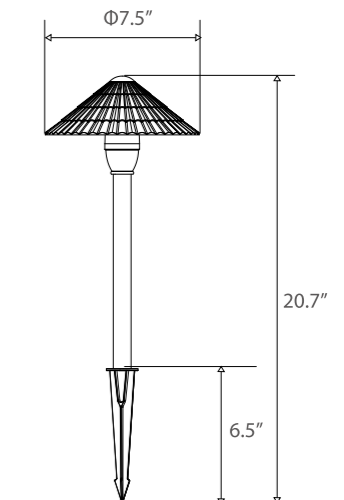
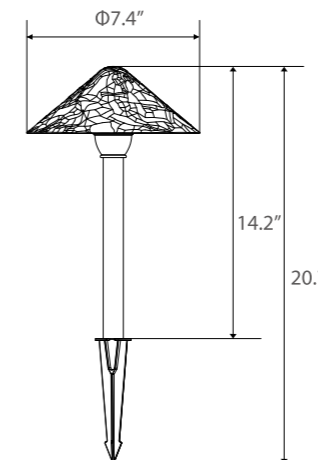

Model	Description	Brightness	Wattage	Color Temp.	CRI	Voltage	PF	Life
MLS-GPLS-13	Umbrella Landscape Light Bronze	147LM	3W	2700K	90+	120Vac 60Hz	≥0.9	50,000
MLS-GPLS-11	Umbrella Landscape Light Satin Archaize	147LM	3W					

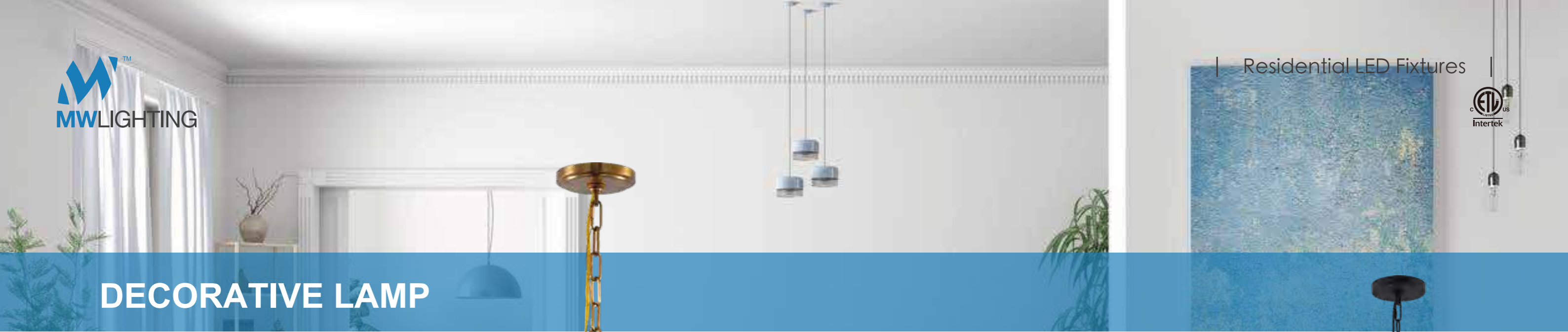

DECORATIVE LAMP

17" Vintage Farmhouse Pendant Light

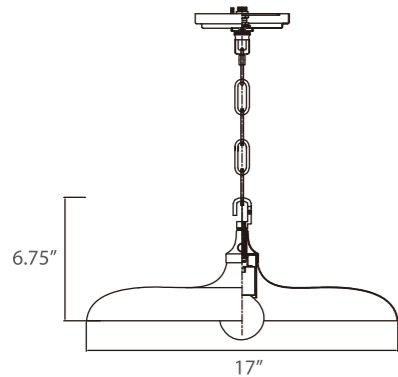

- Featuring a classic styled industrial shade design
- Supporting for 1*E26 base bulbs (Bulbs NOT Included)
- Includes all mounting hardware for quick and easy installation
- ETL certification

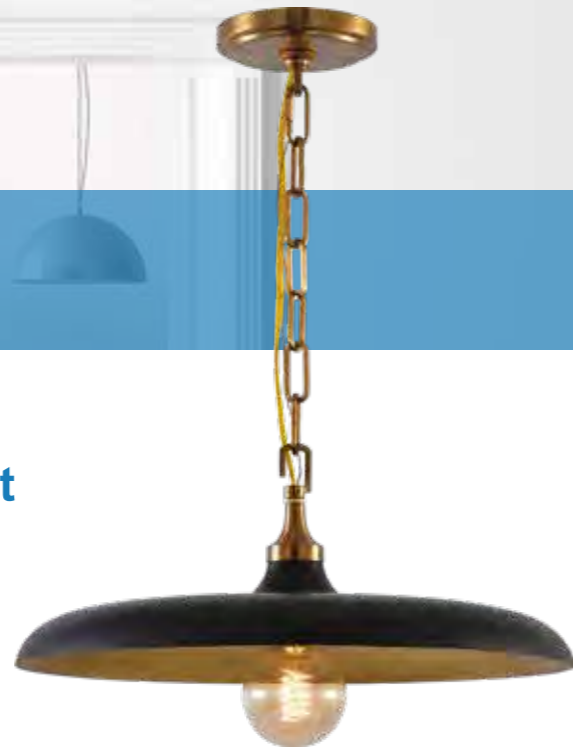

17" Black Farmhouse Pendant Light

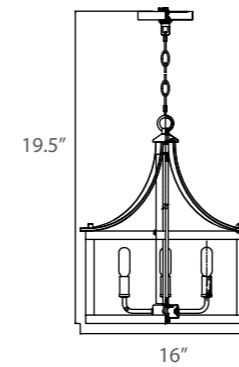

- Adjustable chain to accommodate sloped ceilings
- Compatible with dimmable bulbs and a dimmable switch (NOT included)
- ETL certification
- Includes all mounting hardware for quick and easy installation



Modern Glass Semi Flush Mount Light

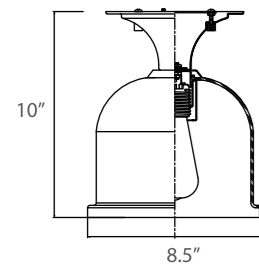

- Includes all mounting hardware for quick and easy installation
- Requires 1x E26/Medium Base 60W Bulb (Bulb not included)
- Compatible with dimmable bulbs and a dimmable switch (NOT included)



4-Light Industrial Farmhouse Pendant Light

- Adjustable chain to accommodate sloped ceilings
- Compatible with dimmable bulbs and a dimmable switch (NOT included)
- ETL certification
- Includes all mounting hardware for quick and easy installation

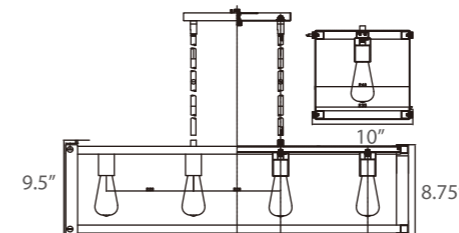



COMMERCIAL LED FIXTURES

- Commercial Downlight
- Troffer Light
- Vapor Light
- Wallpack Light
- Wall Outlet
- Wraparound Light
- High Bay Fixture
- UFO High Bay
- Area Light
- Wall Switch
- Panel Light
- Linear Light
- Flood Light
- Emergency Light
- Electrical Box



COMMERCIAL DOWNLIGHT

3CCT Can-Less Commercial Downlight

- 3 selectable color temperatures
- 3 selectable light output level
- No can housing needed for installation
- 120-277V universal input voltage
- 0-10V smooth dimming down to 5%
- IC rated

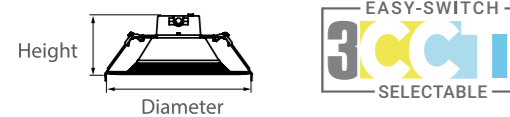

Dimensions	4" model	6" model	8" model	10" model
Diameter	5"	7.48"	10.2"	11.25"
Height	4"	4.17"	4.4"	4.75"



Black Trim Ring optional 6", 8", 10"



Model	Description	Brightness	Wattage	Efficacy	Color Temp.	CRI	Voltage	PF	Life
M4CDLA15W-3CCT	4" Can-less Commercial Downlight	846/1128/1410LM	9/12/15W	94Lm/W	3CCT - 3000/ 4000/ 5000K	80+	120Vac 60Hz	≥0.9	50,000
M6CDLA20W-3CCT	6" Can-less Commercial Downlight	1140/1520/1900LM	12/16/20W	95Lm/W					
M8CDLA27W-3CCT	8" Can-less Commercial Downlight	1448/1953/2524LM	16/21/27W	94Lm/W					
M10CDLA35W-3CCT	10" Can-less Commercial Downlight	2300/3000/3700LM	22/28/35W	105Lm/W					

Modular Design Commercial Downlight

- 4/6/8/10 inch Reflector
- Lens angle up to 50°
- Hardwire or power cord to connect
- Metal housing
- 90+CRI

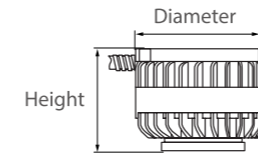

Dimensions	4"/6" model	6"/8"/10" model
Diameter	4.35"	5.55"
Height	3.21"	3.21"



M40 & M60 Light Modular



4"/ 6"/ 8"/ 10" Round Reflector

Model Number	MHCD-20/25/30W-5CCT	MHCD-32/42/55W-35K
Category	M40 Module	M60 Module
Reflectors Suitable for	4"/6"/8"/10" Reflector	6"/8"/10" Reflector
Wattage	20/25/30W	32/40/55W
Rated Lumens	1500/1800/2100LM	3000/4000/5000LM
Color Temp.	5CCT, 2700/3000/3500/4000/5000K	3500K
Efficacy	70-100Lm/W, 80-110Lm/W @CRI80	
Voltage	120-277V or 120-347V AC	
Operating Temp.	-25°C to 40°C	
Life	50,000Hrs	

Key Features



The high efficient Die-casting aluminum heatsink provides excellent heat dissipation for the light module, ensuring enhanced safety for installation and use in insulated ceilings.



The beam angle adjuster is located next to the lens on the front, allowing you to easily choose the light's illumination angle for the best lighting effects.



The lumens and CCT selector can be easily found on the back of the downlight. With just a push of the switch, you can choose the appropriate light brightness and color temperature for your environment.



WRAPAROUND FIXTURE

3CCT & Wattage Adjustable Wraparound Light

- 4FT Wraparound/4FT Wide Wraparound
- 3 selectable color temperatures
- 3 level wattage selectable
- Heavy duty metal frame
- Wide beam spread angle
- 0-10V dimmable

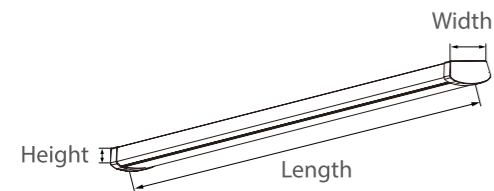

Dimensions	32/40/48W	34/44/54W
Length	47.7"	47.7"
Width	7.1"	9"
Height	2.79"	2.79"

Model	Description	Brightness	Wattage	Efficacy	Color Temp.	CRI	Voltage	PF	Life
METLWRAP05-32/40/48-3CCT	4ft Wraparound	3680/4600/5520LM	32/40/48W	115Lm/W	3CCT-3500/4000/5000K	80+	120-277Vac	≥0.9	50,000
METLWRAP07-34/44/54-3CCT	4ft Wide Wraparound	4114/5192/6210LM	34/44/54W						



3CCT & Wattage Adjustable Backlit Panel Light

- 3 selectable color temperatures and 3 input wattage levels
- Compact design for limited installation spaces
- Aluminum frame with white finish
- 0-10V dimmable
- 120-277Vac universal input voltage
- Optional surface and suspension mount kits available

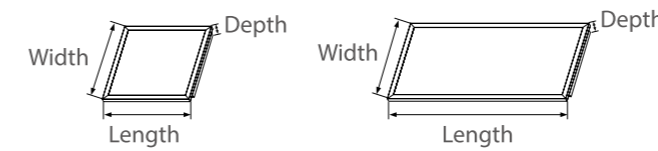

Dimensions	2x2	1x4	2x4
Length	23.3"	47.8"	47.8"
Width	23.3"	11.9"	23.7"
Depth	1.02"	1.02"	1.02"



Model	Description	Brightness	Wattage	Efficacy	Color Temp.	CRI	Voltage	PF	Life
MBLPL14-WS-3CCT	1x4ft Backlit Panel	2200/3300/4400LM	20/30/40W	110Lm/W	3CCT - 3500/4000/5000K	80+	120-277Vac @60Hz	≥0.9	50,000
MBLPL22-WS-3CCT	2x2ft Backlit Panel	2200/3300/4400LM	20/30/40W						
MBLPL24-WS-3CCT	2x4ft Backlit Panel	3300/4400/5500LM	30/40/50W						

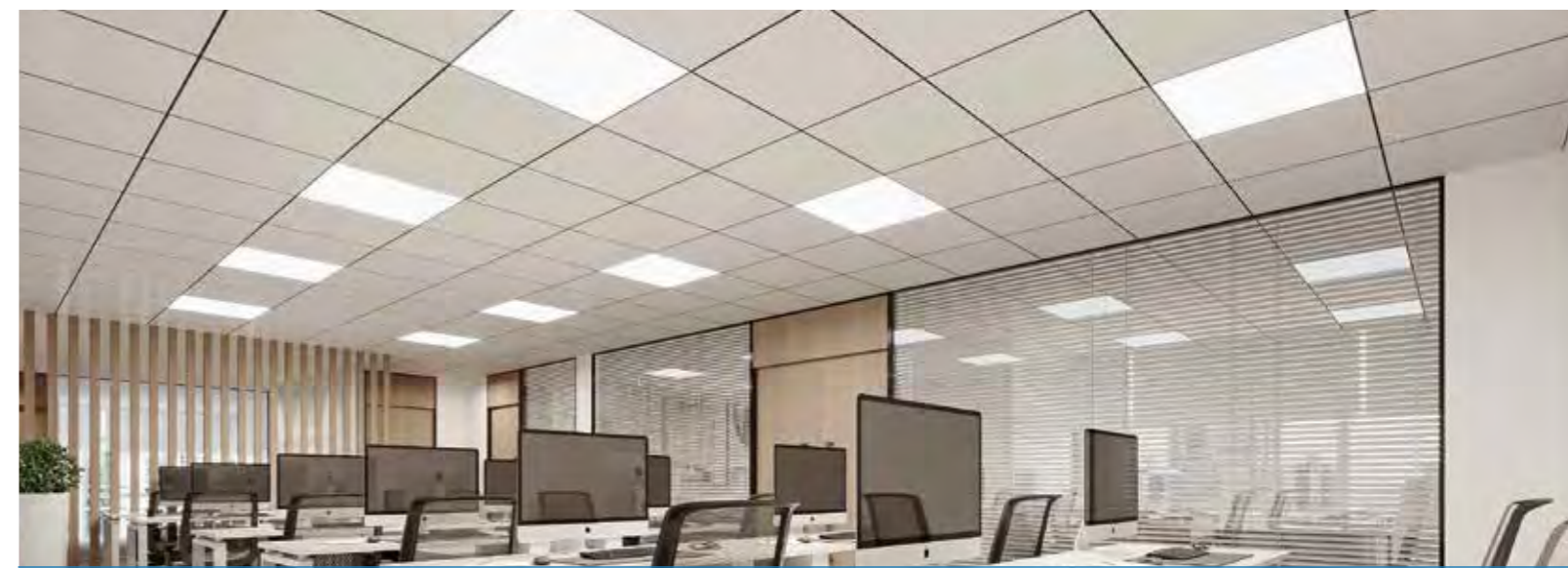

PANEL LIGHT FIXTURE



TROFFER LIGHT FIXTURE

3CCT & Wattage Adjustable Troffer Light

- 2x2 Troffer/2x4 Troffer
- 3 selectable color temperatures and 3 input wattage levels
- Aluminum frame with white finish
- Wide beam spread angle
- 0-10V dimmable
- 120-277Vac universal input voltage
- Designed for mounting directly on the drop ceiling

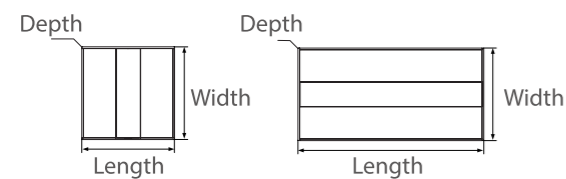

Dimensions	2x2	2x4
Length	23.8"	47.8"
Width	23.8"	23.8"
Depth	3.6"	3.6"

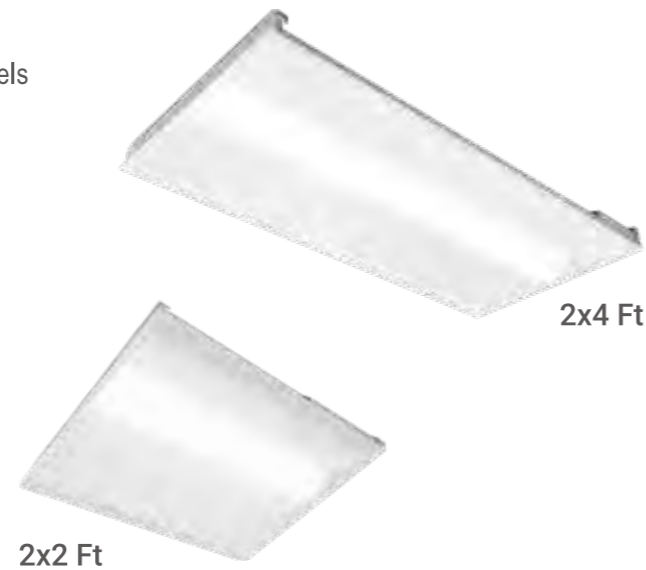

Model	Description	Brightness	Wattage	Efficacy	Color Temp.	CRI	Voltage	PF	Life
MTF22-30/35/40W-3CCT	2x2ft Troffer Light Fixture	3750/4375/5000LM	30/35/40W	125Lm/W	3CCT-3500/4000/5000K	80+	120-277Vac @60Hz	≥0.9	50,000
MTF24-34/38/45W-3CCT	2x4ft Troffer Light Fixture	4250/4750/5625LM	34/38/45W						



Beam Angle Adjustable LED High Bay Fixture

- Available in daylight 5000K
- Steel housing with white finish
- High quality frosted PC lens
- 0-10V dimmable
- 120-277Vac universal input voltage
- DLC and UL certified

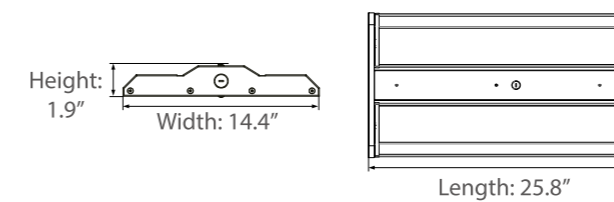

Model	Description	Brightness	Wattage	Efficacy	Color Temp.	CRI	Voltage	PF	Life
MHBAJ24-220W-50K	220W Adjustable LED Linear High Bay	29700LM	220W	135Lm/W	5000K	80+	120-277Vac	≥0.9	50,000



HIGH BAY FIXTURE

LED Compact Low Bay Fixture

- Color temperature: 5000k daylight
- Smooth dimming from 100% to 10%
- Ensures a long lifetime of 50,000 hours
- Brightness & Energy Saving

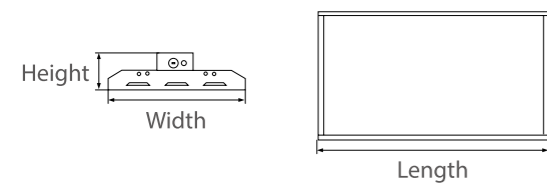

Motion Sensor
(Optional)

Dimensions	115W	155W	210W	300W
Length	16.5"	23.8"	23.8"	45.9"
Width	10.2"	12.9"	17.3"	17.3"
Depth	3.1"	3.6"	3.6"	3.64"

Model	Description	Brightness	Wattage	Efficacy	Color Temp.	CRI	Voltage	PF	Life
MHBS23-115W-50K	115W Single Panel High Bay	18000LM	115W	135Lm/W	5000K	80+	120 to 277Vac @60Hz	≥0.9	50,000
MHBS23-155W-50K	155W Single Panel High Bay	20925LM	155W						
MHBS24-210W-50K	210W Single Panel High Bay	28350LM	210W						
MHBS43-300W-50K	300W Single Panel High Bay	40500LM	300W						
MHBS23-115W-50K-MS	115W Single Panel High Bay with Motion Sensor	18000LM	115W						
MHBS23-155W-50K-MS	155W Single Panel High Bay with Motion Sensor	20925LM	155W						
MHBS24-210W-50K-MS	210W Single Panel High Bay with Motion Sensor	28350LM	210W						
MHBS43-300W-50K-MS	300W Single Panel High Bay with Motion Sensor	40500LM	300W						

Twin Panel LED Linear High Bay Fixture

- 155W/170W/210W
- Steel housing with white finish
- High quality frosted PC lens
- Wide beam spread angle

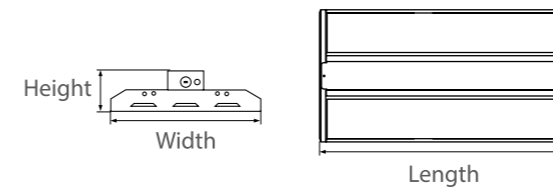

Motion Sensor
(Optional)

Dimensions	155W	170W	210W
Length	24.4"	24.4"	24.4"
Width	14.9"	15"	19"
Depth	2.16"	2.16"	2.16"

Model	Description	Brightness	Wattage	Efficacy	Color Temp.	CRI	Voltage	PF	Life
MHB24-155W-50K	155W Double Panel High Bay	20925LM	155W	135Lm/W	5000K	90+	120 to 277Vac @60Hz	≥0.9	50,000
MHB26-210W-50K	210W Double Panel High Bay	28350LM	210W						
MHB24-170W-40/50K	170W Double Panel High Bay, 2CCT	22950LM	170W		2CCT - 4000/5000K				
MHB26-210W-40/50K	210W Double Panel High Bay, 2CCT	28350LM	210W		5000K				
MHB24-155W-50K-MS	155W Double Panel High Bay with Motion Sensor	20925LM	155W						
MHB26-210W-50K-MS	210W Double Panel High Bay with Motion Sensor	28350LM	210W						



LED LINEAR LIGHT FIXTURE

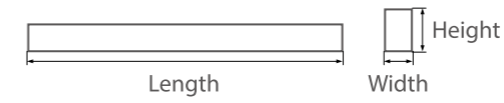

Dimensions	2ft	4ft	8ft
Length	24.5"	48.1"	95.7"
Width	2.1"	2.1"	2.1"
Depth	3.2"	3.2"	3.2"



Model	Description	Brightness	Wattage	Efficacy	Color Temp.	CRI	Voltage	PF	Life
MAST-2FT-15/20/25W-3CCT	2ft LED Up and Down Linear Light	1725/2300/2875LM	35/40/50W	115Lm/W	3CCT-3500/4000/5000K	90+	120-347Vac	≥0.9	50,000
MAST-4FT-40/45/50W-3CCT	4ft LED Up and Down Linear Light	4600/5175/5750LM	40/45/50W						
MAST-8FT-65/75/90W-3CCT	8ft LED Up and Down Linear Light	7475/8625/10350LM	65/75/90W						

3CCT LED Up and Down Strip Light Fixture

- 115-120 lm/W, 1700lm-10800lm
- Field-adjustable Power and CCT
- Direct-Indirect flux ratio adjustable
- Fast and seamless connection thanks to patent tool-free press lock design
- Continuous run available
- Multiple connection methods
- Sensor and EM solution ready

Fast and Seamless Connection

Screw-free to remove end-cover.
Tool-free press lock connection

Distributions

Direct-Indirect flux ratio adjustable

	Direct	Indirect
100%	100%	0%
70%	70%	30%
50%	50%	50%

Multiple Connection Method

Continuous luminous surface. Change to DIY soft lens which can be cut by users for seamless continuous run.

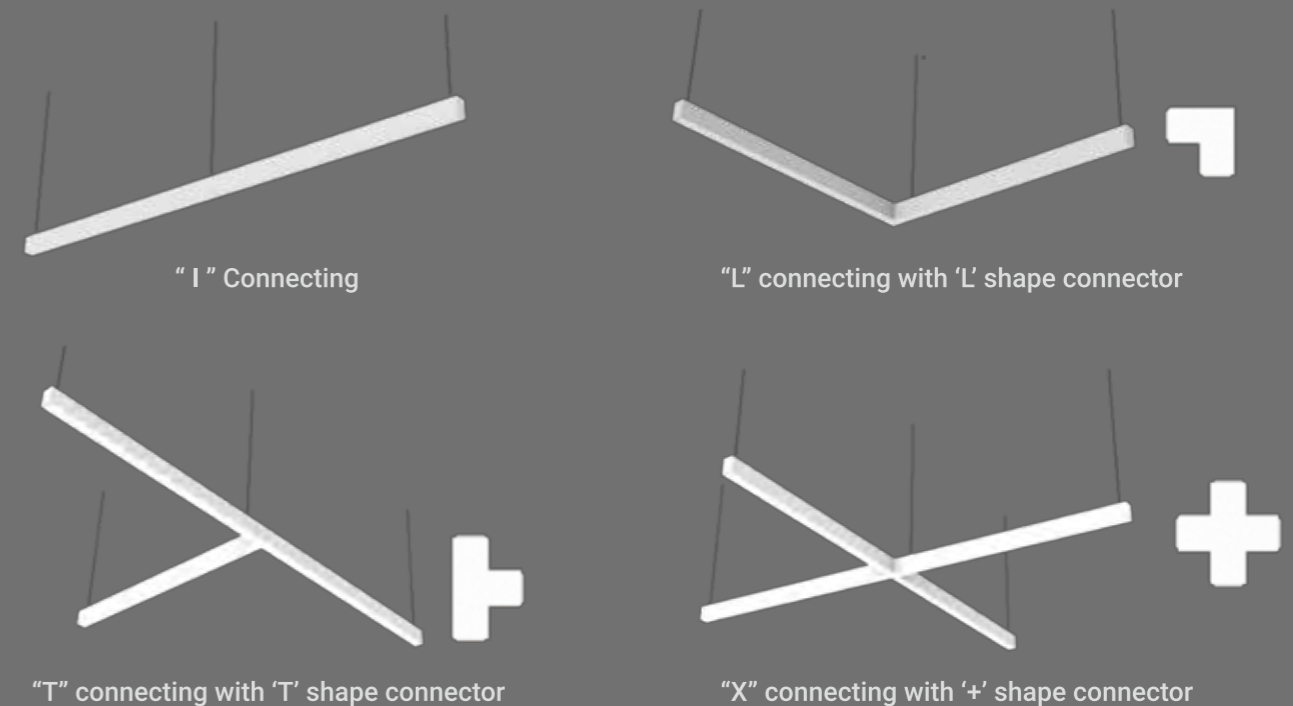



LED STRIP LIGHT FIXTURE

3CCT & Wattage Adjustable Strip Light Fixture

- Wattage and CCT selectable
- Metal housing with white finish
- 0-10V dimmable
- 120-277Vac universal input voltage
- DLC and UL certified

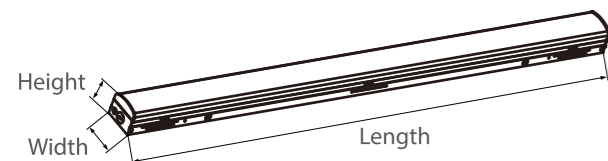

Dimensions	4ft	8ft
Length	47.36"	94.17"
Width	2.82"	7.21"
Depth	2.44"	6.42"

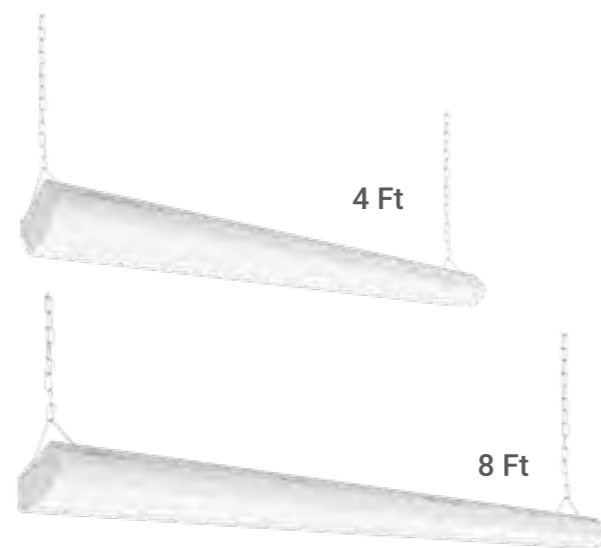

Model	Description	Brightness	Wattage	Efficacy	Color Temp.	CRI	Voltage	PF	Life
MSTM4FT-34/38/45W-3CCT	4ft Strip Light Fixture	4420/4940/5850LM	34/38/45W	130Lm/W	3CCT - 3500/4000/5000K	80+	120-277Vac @60Hz	≥0.9	50,000
MSTM8FT-65/75/90W-3CCT	8ft Strip Light Fixture	8450/9750/11700LM	65/75/90W						



3CCT & Wattage Adjustable Strip Light Fixture

- Wattage and CCT selectable
- Metal housing with white finish
- 0-10V dimmable
- 120-277Vac universal input voltage
- DLC and UL certified

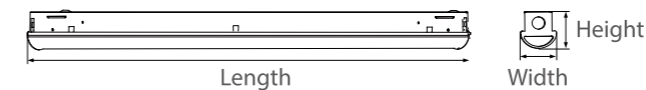

Dimensions	4ft Narrow	4ft	8ft
Length	47.25"	47.25"	96"
Width	2.38"	3.38"	3.38"
Depth	2.88"	3.75"	3.75"

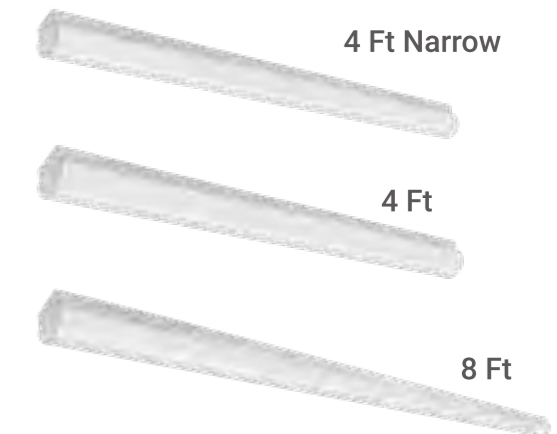

Model	Description	Brightness	Wattage	Efficacy	Color Temp.	CRI	Voltage	PF	Life
MST4FT-N-22/28/40W-3CCT	4ft Narrow Strip Light Fixture	2860/3640/5200LM	22/28/40W	130Lm/W	3CCT - 3500/4000/5000K	80+	120-277Vac @60Hz	≥0.9	50,000
MST4FT-34/38/45W-3CCT	4ft Strip Light Fixture	4420/4940/5850LM	34/38/45W						
MST8FT-65/75/90W-3CCT	8ft Strip Light Fixture	8450/9750/11700LM	65/75/90W						

Strip Light With Emergency Driver

- Wattage and CCT selectable
- Metal housing with white finish
- 0-10V dimmable
- 120-277Vac universal input voltage
- DLC and UL certified

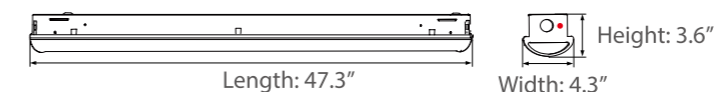

Model	Description	Brightness	Wattage	Efficacy	Color Temp.	CRI	Voltage	PF	Life
MST4FT-34/38/45W-3CCT-EM	4FT LED Strip Light EMERGENCY	4420/4940/5850LM	34/38/45W	130Lm/W	3CCT-3500/4000/5000K	80+	120-277Vac	≥0.9	50,000



LED VAPOR LIGHT FIXTURE

Vapor Tight Fixture 3CCT & Wattage Selectable

- Available in 3500K, 4000K, 5000K
- Plastic housing with white finish
- High quality frosted PC lens
- 0-10V dimmable
- 120-277Vac universal input voltage
- DLC and UL certified
- IP 65

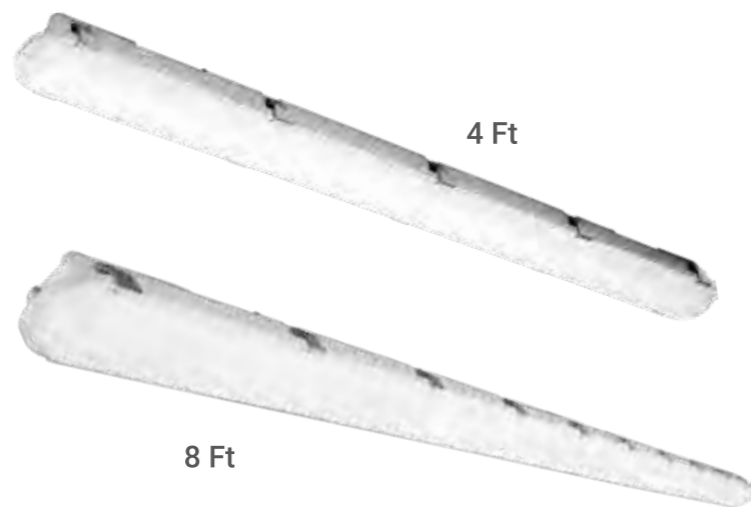
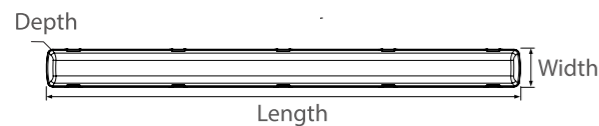

Dimensions	4ft	8ft
Length	47.5"	94.5"
Width	5"	5"
Depth	3.5"	3.5"



Model	Description	Brightness	Wattage	Efficacy	Color Temp.	CRI	Voltage	PF	Life
MVP4FT-34/38/45W-3CCT	4ft Vapor Tight Fxture	4420/4940/5850LM	34/38/45W	130Lm/W	3CCT - 3500/4000/5000K	80+	120-277Vac @60Hz	≥0.9	50,000
MVP8FT-65/75/90W-3CCT	8ft Vapor Tight Fxture	8450/9750/11700LM	65/75/90W						



LED AREA LIGHT FIXTURE

High-Output Shoebox Area Light

- High lumen output
- Heavy duty die-cast aluminum housing
- 120-277V universal input voltage, surge protection: 6KV
- Min. Start temperature -40°F
- Photocell control optional
- Bronze Finish

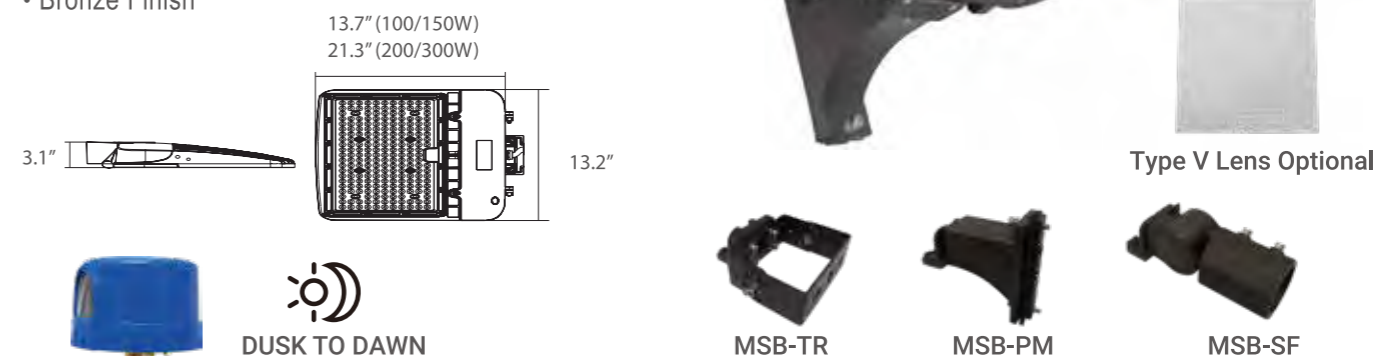

Model	Description	Brightness	Wattage	Efficacy	Color Temp.	CRI	Voltage	PF	Life
MSB-100/150/200W-50K	LED Shoebox 100/150/200W	13000/19500/26000LM	100/150/200W	130Lm/W	5000K	80+	120-277V	≥0.9	50,000
MSB-100/150/200W-50K-SB	LED Shoebox 100/150/200W with Socket Base	13000/19500/26000LM	100/150/200W						
MSB-200/240/300W-50K	LED Shoebox 200/240/300W	26000/31200/39000LM	200/240/300W	130Lm/W	5000K	80+	120-277V	≥0.9	50,000
MSB-200/240/300W-50K-SB	LED Shoebox 200/240/300W with Socket Base	26000/31200/39000LM	200/240/300W						



LED UFO HIGH BAY FIXTURE

3CCT LED UFO High Bay

- 3 selectable color temperature
- 3 selectable light output level
- 100/120/150W or 150/200/240W
- Black or White
- 0-10V Smooth dimming down to 5%
- Optional motion sensor

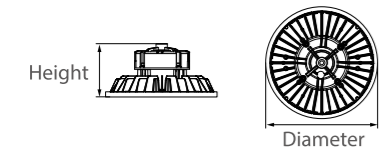

Dimensions	100/120/150W	150/200/240W
Diameter	10.24"	12.6"
Height	6.4"	6.89"

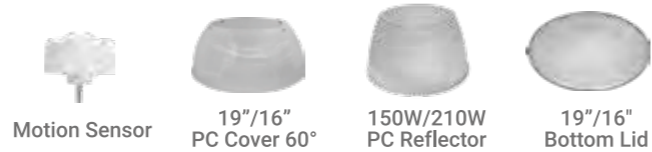

Model	Description	Brightness	Wattage	Efficacy	Color Temp.	CRI	Voltage	PF	Life
MUHB-100/120/150-3CCT	3CCT UFO High Bay, Black	14000/16800/21000LM	100/120/150W	140Lm/W	3CCT - 3000/4000/5000K	80+	120-277Vac @60Hz	≥0.9	50,000
MUHB-100/120/150-3CCT-WH	3CCT UFO High Bay, White	14000/16800/21000LM	100/120/150W						
MUHB-150/200/240-3CCT	3CCT UFO High Bay, Black	21000/28000/33600LM	150/200/240W						
MUHB-150/200/240-3CCT-WH	3CCT UFO High Bay, White	21000/28000/33600LM	150/200/240W						



2CCT LED UFO High Bay

- 2 selectable color temperature
- 3 selectable light output level
- 100/120/150W or 150/200/240W
- Black or White
- 0-10V Smooth dimming down to 5%
- Optional motion sensor

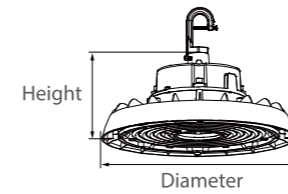

Dimensions	100/120/150W	150/200/240W
Diameter	10.4"	12.8"
Height	7.1"	7.3"

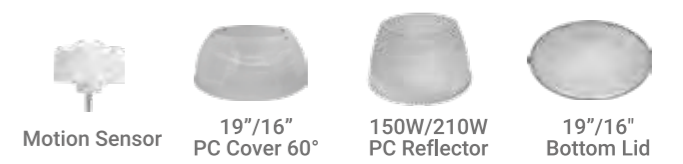

Model	Description	Brightness	Wattage	Efficacy	Color Temp.	CRI	Voltage	PF	Life
MEUHB-100/120/150-2CCT	2CCT UFO High Bay, Black	13500/16875/20250LM	100/120/150W	135Lm/W	2CCT - 4000/5000K	80+	120-277Vac @60Hz	≥0.9	50,000
MEUHB-100/120/150-2CCT-WH	2CCT UFO High Bay, White	13500/16875/20250LM	100/120/150W						
MEUHB-150/200/240-2CCT	2CCT UFO High Bay, Black	20250/27000/32400LM	150/200/240W						
MEUHB-150/200/240-2CCT-WH	2CCT UFO High Bay, White	20250/27000/32400LM	150/200/240W						

LED UFO NSF-Rated High Bay Light

- 5000K-White
- 3 selectable light output level
- 100/150/200W
- IP69
- 0-10V Smooth dimming down to 5%
- Optional motion sensor

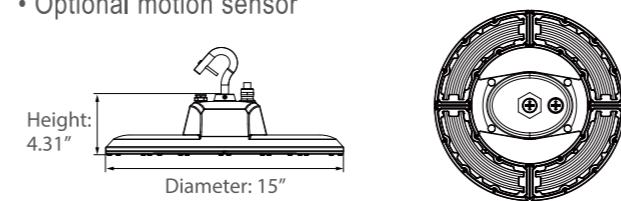

Model	Description	Brightness	Wattage	Efficacy	Color Temp.	CRI	Voltage	PF	Life
MUHB-100/150/200-50K-WH	LED UFO NSF-Rated High Bay	15000/22500/30000LM	100/150/200W	150Lm/W	5000K	80+	120-277Vac	≥0.9	50,000



LED FLOOD LIGHT & WALLPACK

3CCT & Wattage Adjustable Flood Light

- 3 selectable color temperature
- 3 level wattage selectable
- High lumen output
- Heavy duty die-cast aluminum housing
- Architectural baked polyester powder coating
- 120-277V universal input voltage
- Min. Start temperature -40°F
- Photocell control optional
- Bronze Finish
- Knuckle & U Bracket included

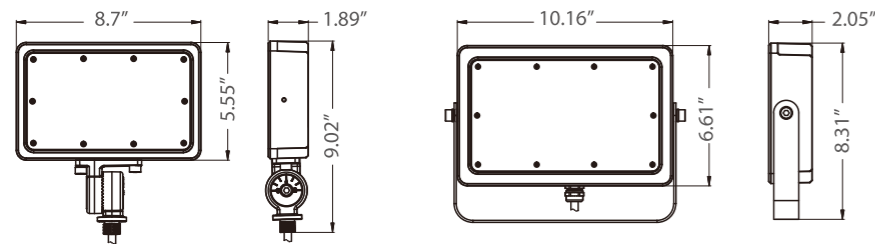

Model	Description	Brightness	Wattage	Efficacy	Color Temp.	CRI	Voltage	PF	Life
MFL-30/40/50W-3CCT	LED Flood Light	3900/5200/6500LM	30/40/50W	135Lm/W	3000/4000 /5000K	80+	120 to 277Vac 60Hz	≥0.9	50,000
MFL-80/90/100W-3CCT	High Output LED Flood Light	9100/10400/11700LM	80/90/100W						



3CCT & Wattage Adjustable Commercial Wallpack

- 3 selectable color temperature and 3 level wattage selectable
- High lumen output
- Heavy duty die-cast aluminum housing
- Architectural baked polyester powder coating
- Min. Start temperature -40°F
- Photocell control optional
- Tempered and impact resistant prismatic borosilicate glass
- Bronze Finish

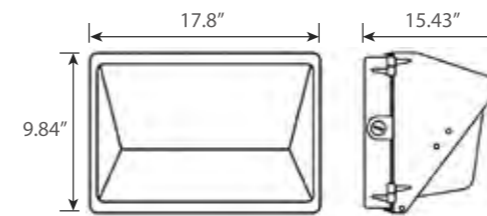

Model	Description	Brightness	Wattage	Efficacy	Color Temp.	CRI	Voltage	PF	Life
MWP-40/50/60W-3CCT	LED Wallpack Fixture	5600/7000/8400LM	40/50/60W	140Lm/W	3500/4000 /5000K	80+	120 to 277Vac 60Hz	≥0.9	50,000
MWP-80/100/120W-3CCT	LED Wallpack Fixture	11200/14000/16800LM	80/100/120W						

5000K Mini Wallpack

- Super bright LED SMD2835
- Lumen output: 110LM/W(5000K)
- AC120V
- Designed with semi-cutoff feature
- IP 65 Waterproof
- Temperature: -4°F-122°F(-20°C to 50°C) CRI>80, PF>0.9, THD<20%
- Daylight sensor

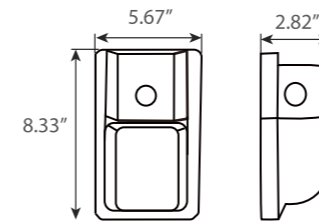

Model	Description	Brightness	Wattage	Efficacy	Color Temp.	CRI	Voltage	PF	Life
MWP-28W-50K	LED Mini Wallpack	3080LM	28W	110Lm/W	5000K	80+	120Vac	≥0.9	50,000



MJ-1L

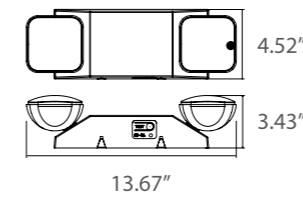

MJ-7

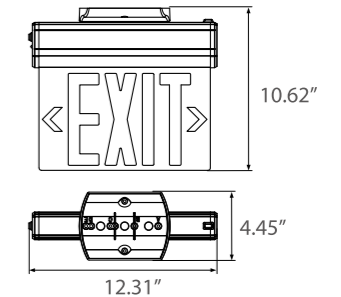

LED EMERGENCY EXIT LIGHT

LED Emergency EXIT Light

- Optional Red or Green exit sign
- Built-in 700mAH rechargeable Ni-cd battery
- Minimum 90 minutes emergency operation
- Fully recharge in 24 hours
- Test switch and charge indicator



MJ-30

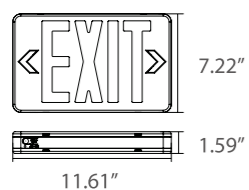

MJ-2

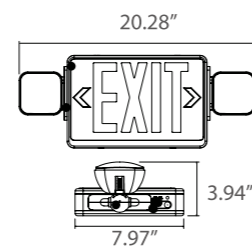

Model	Description	Finish Color	Wattage	Brightness	Color Temp.	Emergency Operation	Life Hours
MJ-30	Red Exit Sign	Red	N/A	N/A			
MJ-30G	Green Exit Sign	Green	N/A	N/A	N/A		
MJ-30RG	Red / Green Exit Sign	Red/Green	N/A	N/A			
MJ-2	Red Combo Exit Sign	Red	3W	N/A			
MJ-2G	Green Combo Exit Sign	Green	3W	150LM	5000K	≥90mins	50,000
MJ-2RG	Red/ Green Combo Exit Sign	Red/Green	3W	150LM			
MJ-7-2M	Red Combo Exit Sign	Red	N/A	N/A			
MJ-7G-2M	Green Combo Exit Sign	Green	N/A	N/A	N/A		
MJ-1L	Dual Heads Emergency Light	N/A	2.4W	150LM	5000K		



WALL OUTLET

Wall Outlet With USB Plus Type-C Socket

Enhance your charging convenience with our Duplex Wall Outlet. This smart solution features two traditional sockets alongside a USB plus a Type-C socket, offering versatile charging options for all your devices. Modernize your space while staying connected.

- Features USB plus Type-C socket
- UL listed

Model	Description
MR-UC-4.8A	USB+Type C Receptacle



Decora Duplex Wall Outlet

Elevate your power access with our Decora Dual-Socket Duplex Wall Outlet. Modern, safe, and space-saving, it's an essential addition to any space.

- Dual outlet
- UL listed
- Tamper Resistant

Model	Description	Gangs	Voltage	Amperage
MR-TR-15	15amp Decora Duplex Wall Outlet	1	125V	15A
MR-TR-20	20amp Decora Duplex Wall Outlet	1	125V	20A



Self-Test Duplex GFCI Outlet

Equipped with a self-test button, this advanced outlet automatically detects and prevents electrical hazards. Ideal for kitchens, bathrooms, and outdoors. Stay protected and powered up.

- Self-Test button
- Dual outlet
- UL listed
- Tamper Resistant
- Weather Resistant

Model	Description	Gangs	Voltage	Amperage
MG-15-TRWR	15Amp GFCI outlet	1	125V	15A
MG-20-TRWR	20Amp GFCI outlet	1	125V	20A





WALL SWITCH

Decora Duplex Wall Outlet

Elevate your power access with our Decora Dual-Socket Duplex Wall Outlet. Modern, safe, and space-saving, it's an essential addition to any space.

- Dual outlet
- UL listed



Model	Description	Voltage
MWS-01	Single Rocker Switch	125V
MWS-02	Double Rocker Switch	125V

Decora Switch Wall Plate

Crafted for both style and protection, these switch covers add a touch of elegance to your switches while keeping them safe from dust and dirt. Choose from a variety of designs to match your aesthetic.

- Slim and modern design

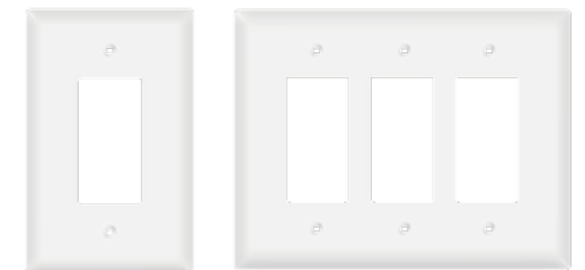

Model	Description	Gangs
MSC-01	1 Gang Wall Plate	1
MSC-02	2 Gang Wall Plate	2
MSC-03	3 Gang Wall Plate	3
MSC-SL-01	1 Gang Screwless Wall Plate	1
MSC-SL-02	2 Gang Screwless Wall Plate	2
MSC-SL-03	3 Gang Screwless Wall Plate	3



ELECTRICAL BOX

Electrical and Outlet Box

A compact solution for seamless electrical connections. Designed for easy installation and safety, this box provides a secure housing for switches and outlets.



Model	Description	Cubic Inch	Material
MOB-1G-18	1-GANG Nail-on Electrical Box	18	Heavy Duty Plastic
MOB-1G-20	1-GANG Nail-on Electrical Box	20	
MOB-1G-22	1-GANG Nail-on Electrical Box	22	
MOBR-1G-14	1-GANG Remodel Electrical Box	14	
MOBR-1G-20	1-GANG Remodel Electrical Box	20	
MOB-2G-32	2-GANG Nail-on Electrical Box	32	
MOBR-2G-25	2-GANG Remodel Electrical Box	25	
MOB-3G-44	3-GANG Nail-on Electrical Box	44	
MOB-4G-60	4-GANG Nail-on Electrical Box	60	

Round Electrical Outlet Box

The perfect fusion of style and functionality. Its sleek circular design seamlessly accommodates switches and outlets, enhancing any space's aesthetics. Built for durability, easy installation, and safety, this box offers a secure home for electrical connections.



Model	Description	Cubic Inch	Material
MOB-R-20	Round Nail-on Electrical Box	20	Heavy Duty Plastic
MOB-HR-20	Round Nail-on Electrical Box With Hang Bar	20	
MOBR-R-18	Round Old Work Electrical Box	18	

ACCESSORIES

- Motion Sensor
- Cabinet Light Cable
- Trim Ring
- Mount Plate
- Panel Light Kits
- UFO Accessories
- Emergency Driver
- Strip Light Chain

High/Low Bay Motion Sensor

- Features passive infrared technology
- 0-10V dimming sensor
- 120-277Vac universal input voltage
- Available in high bay and low bay version
- Max 30ft detection radius with 360° coverage



Model	MBRI819-B-D	MBRI819-B-O
Product Type	Bi-level passive infrared occupancy sensor	120-277V on/off passive infrared occupancy sensor
Rated Input Voltage	120-277 Vac	
Max Load/Output	Resistive/Tungsten-600W@120V Electronic Ballast-800W@120V/1200W@277V	
Mounting Height	Low Bay-25ft max/High Bay-40ft max	
Dimmable Function	0-10V	
Detection Radius	30ft	
Coverage	360°	
Operating Temp.	-40 to 167°F	
IP Rating	IP 20	
Safety Certificate	UL	

Extension Cable for Canless Downlight

M3FTCABLE / M10FTCABLE

Compatible

- Compatible with all MW Canless Downlight models
- Available in 3ft and 10ft model



6ft Power Cable For Cabinet Light

The power cable is designed to make your kitchen project easier.

Key Features

- Compatible with all MW Cabinet Light



MUC-PC-6FT

Extension Cable For Cabinet Light

Simple plug to connect two lights together. The Extension/Connection cable is designed to make your kitchen project easier.

Key Features

- Compatible with all MW Linkable Cabinet Light
- Available in 6" and 12" model



MU-EC-6IN

MU-EC-12IN





DECORATIVE TRIM RING

Trim Ring For Canless Downlight

The MW trim ring allows you to change the look or style of your MW Ultra-Slim downlight / Commercial downlight. Easy to install, no tools are needed.

| For Ultra-slim Downlight



Matte Black Brush Bronze Brush Nickel

Key Features

- Use for MW Ultra-Slim series downlight.
- Easy to install, no tools needed.
- Available in brush bronze, brush nickel and matte black
- Available in 3"/4"/6"

Compatible

- MRSD3 series
- MRSD4 series
- MRSD6 series

| For Commercial Downlight

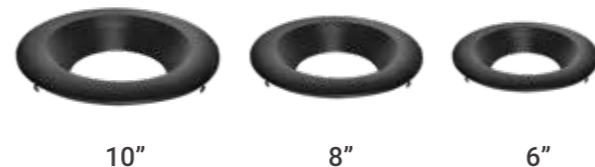

10" 8" 6"

Key Features

- Use for MW Commercial series downlight.
- Easy to install, no tools needed .
- Matte black
- Available in 6"/8"/10"

Compatible

- M6CDLA20W-3CCT
- M8CDLA27W-3CCT
- M10CDLA35W-3CCT

Mount Plate for 2"/3"/4"/6" Canless Downlight

MRSDMP-W/H-346

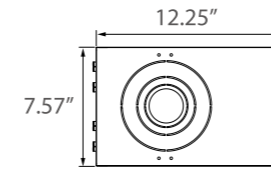

Construction

- Unit includes steel mount plate, extend hanger bar and nails

Mounting

- Above ceiling
- Ceiling joists & drop ceiling installations



Compatible

- MW ultra-slim canless 5CCT downlights in 3", 4" and 6"
- MW canless gimbal downlights in 2", 3" and 4"
- MW canless swivel downlights in 4" and 6"
- MW Trimless downlight 2" and 3"

Mount Plate for 4"/6"/8" Canless Downlight

MRSDMP-468

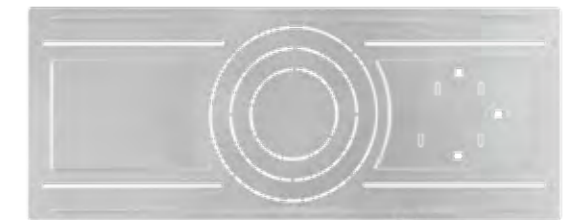
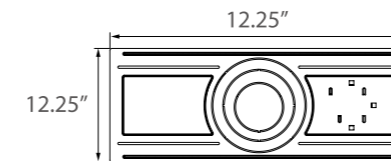

Construction

- Unit includes steel mount plate

Mounting

- Above ceiling
- Ceiling joists & drop ceiling installations

Compatible

- MW ultra-slim canless 5CCT downlights in 4", 6" and 8"
- MW canless gimbal downlights in 4"
- MW canless swivel downlights in 4" and 6"

Mount Plate for 2"/3"/4"/6"/8" Canless Downlight with J-BOX

RBMP-2468-JB



Key Features

- Alignment Notches For Easy Alignment Of Multiple Plates
- Durable Housing Resistant To Rust And Impact
- J-BOX Position Can Be Secured
- Options For 2", 3", 4", 6", 8" LED Recessed Lights



PANEL LIGHT KITS

Suspension Mount Kits

The Suspension Mounting Wire kit allows LED Panel Lights to be hung from the ceiling while recessed mounting is not possible. One end of the suspension kit screws to ceiling.



MW-CP-5FT-A

Key Features

- Easy to install

Compatible

- Compatible with all panels with screw on the back

Surface Mount Kits

The Surface Mounting Kits allows LED Panel Lights to be installed on the surface from the Ceiling while recessed mounting is not possible.

Key Features

- Easy to install
- High quality aluminum
- Compatible with all MW panel lights

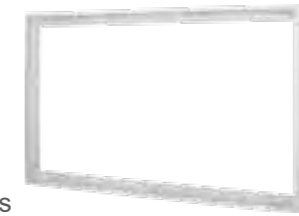

MW-24-SMKIT-80MM



MW-22-SMKIT-80MM



MW-14-SMKIT-80MM

Dimensions	2x4ft Model	2x2ft Model	1x4ft Model
Length (inch)	48	24	48
Width (inch)	24	24	12
Depth (inch)	3.15	3.15	3.15

Flange Kits For Backlit Panel

The Surface Mounting Kits allows LED Panel Lights to be recessed mounted on the drywall ceiling.

Key Features

- Easy to install
- High quality aluminum
- Compatible with all MW panel lights



M24-FK



M22-FK



M14-FK

Dimensions	2x4ft Model	2x2ft Model	1x4ft Model
Length (inch)	47.25	25	47.25
Width (inch)	25	25	13.25
Depth (inch)	1.25	1.25	1.25



UFO HIGH BAY ACCESSORIES

Pendant Mounting Bracket For UFO High Bay Fixture

MUHB-PD



90 Degree PC Reflector For UFO High Bay, available in 16" & 19"

MUHB-19-RF-PC / MUHB-16-RF-PC



12-24V Plug-In PIR Motion Sensor For UFO High Bay Fixture

ANT-6-4T



PC Reflector Bottom Lens For UFO High Bay, available in 16" & 19"

MUHB-16-BOTTOM-LENS



Adjustable U-Mount Bracket For UFO High Bay Fixture

MUHB-U-BRACKET



Emergency Driver

- UL Listed for damp locations.
- DC120-190V Output.
- Initial functional self-check.
- Used with Lithium iron battery.
- Over-charging/discharging protection
- >90 minutes emergency time.
- Suited for 10-32W below lamp with or without 0-10v dimming function.
- Built-in high power AC relay to control normal led driver operation.



Model	RBHV-8W-EM-170V	RBHV-18W-EM-170V	RBHV-32W-EM-170V	MHV-25W-EM-110V
Rated Input	100-277Vac, 50/60Hz, 5W max	100-277Vac, 50/60Hz, 5W max	100-277Vac, 50/60Hz, 8W max	100-277Vac, 50/60Hz, 25W max
Output Voltage	DC150-170V, 8W	DC150-170V, 18W	DC150-170V, 32W	DC110V, 25W
Output Power	8W	18W	32W	25W
Recharge Time	≥24 Hours	≥24 Hours	≥36 Hours	≥24 Hours
Suitable Lamp Power	6-80W	10-150W	10-300W	≤25W
Input Current	120mA max			
Operating Temp.	41 to 122°F			
IP Rating	IP 20			
Safety Certificate	UL			

Strip Light Chain

The Suspension Mounting Wire kit allows LED Strip Lights to be hung from the ceiling while recessed mounting is not possible.



STRIP-S-VOOK-CHAIN
(Narrow Strip)



STRIP-N-VOOK-CHAIN
(MST & MSTM Series)

Key Features

- Easy to install